

ASSEMBLY INSTRUCTIONS

BUNK HOUSE BED + SLIDE

Thank you for purchasing this quality product. Be sure to check all packing materials carefully for small parts which may have come loose inside the carton during shipment. Separate, identify and count all parts and hardware. Compare with the parts list to be sure all parts are present.

**“DO NOT TIGHTEN SCREWS
UNTIL COMPLETELY ASSEMBLED”**

SIZE OF MATTRESS AND FOUNDATION (SUPPO

This bed is designed to use a twin mattress (37½"-38½"x74-75) and bunkie board (37½ x74). The total thickness must not exceed 8" inches. Do not use mattress without the proper bunkie board of safe foundation.

Note: There must be at least 5" inches from top surface of mattress to top edge of guardrails.

REPLACEMENT PARTS.

Replacement parts, including additional guardrails, may be obtained from place of purchase or original distributor.

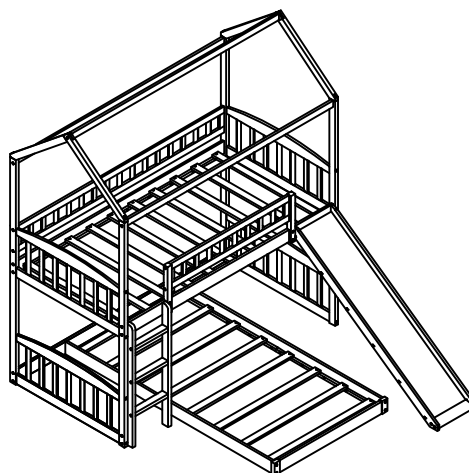

SAFETY WARNINGS!

- 1- Follow the information on the warning label appearing on the upper bunk end structure and on the carton. Do not remove warning label from bed.
- 2- Always use the recommended size mattress or mattress support, or both, to help prevent the likelihood of entrapment or falls.
- 3- Surface of mattress must be at least 5 inches below the upper edge of guardrails.
- 4- Do not allow children under 6 years of age to use the upper bunk.
- 5- Prohibit more than one person on upper bunk.
- 6- Periodically check and ensure that the guardrail, ladder and other components are in their proper position free from damage, and that all connectors are tight.
- 7- Do not allow horseplay on or under the bed and prohibit jumping on the bed.
- 8- Always use the ladder for entering and leaving the upper bunk.
- 9- Do not use substitute parts. Contact distributor or dealer for replacement parts.
- 10- Use of a night light may provide added safety precaution for a child using the upper bunk.
- 11- If the bunk bed will be placed next to a wall, the guardrail that runs the full length of the bed should be placed against the wall to prevent entrapment between the bed and the wall.
- 12- Always use guardrails on both long sides of the upper bunk.
- 13- The use of water or sleep flotation mattresses is prohibited.
- 14- Keep these instructions for future reference.
- 15- Strangulation Hazard - Never attach or hang items to any part of the bunk bed that are not designed for use with the bed: for example, but not limited to, hooks, belts, and jump ropes, etc.



IMPORTANT: PLEASE READ INSTRUCTIONS BEFORE STARTING THE ASSEMBLY

ASSEMBLY INSTRUCTIONS

BUNK HOUSE BED + SLIDE

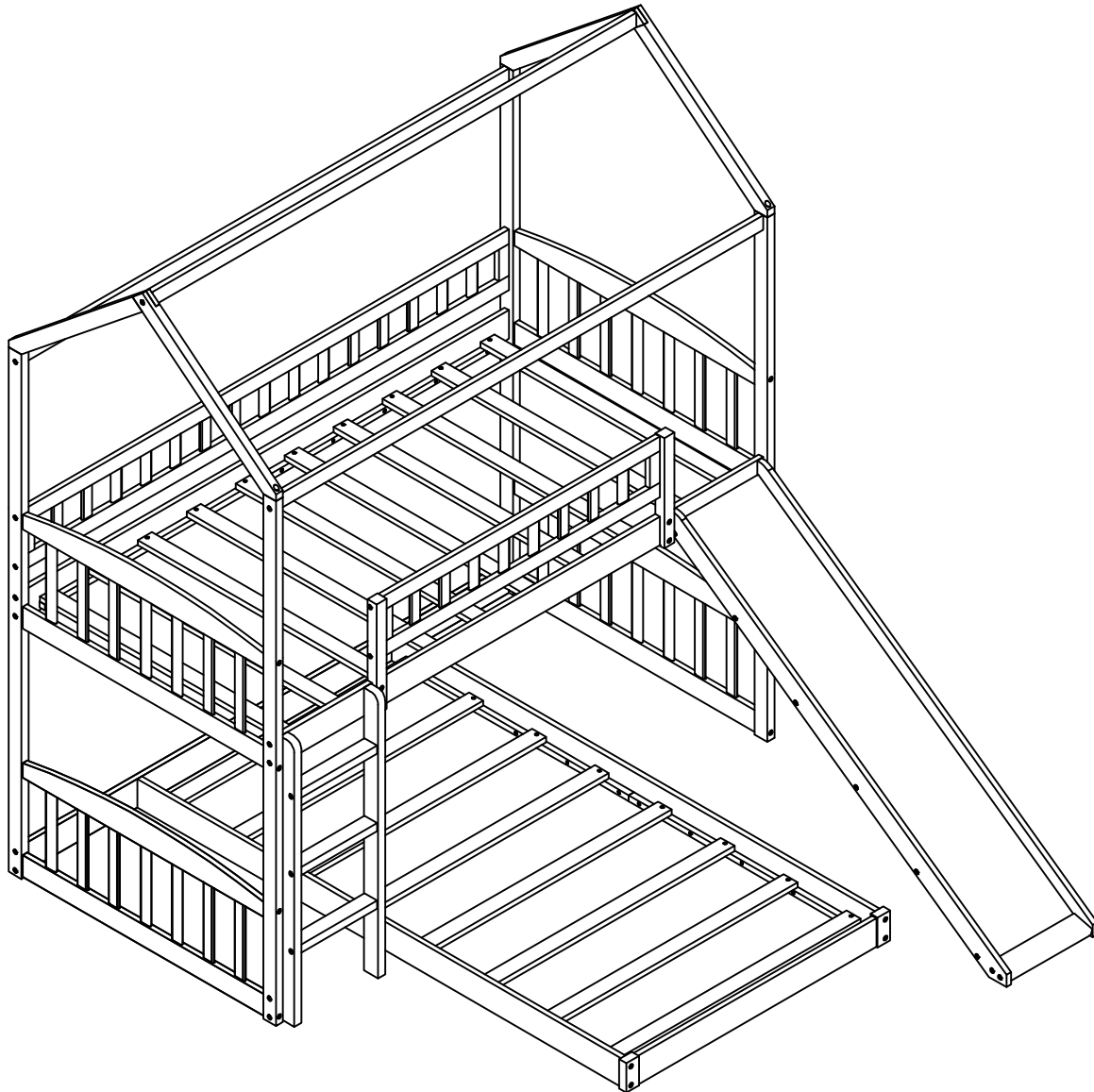

Thank you for purchasing this quality product. Be sure to check all packing material carefully for small parts which may have come loose inside the carton during shipment. Separate, identify and count all parts and hardware.

Compare with the parts list to be sure all parts are present.

"DO NOT TIGHTEN SCREWS UNTIL COMPLETELY ASSEMBLED"

- Use of power tool to assemble this product will invalidate any claim and damage this product making unsafe !!!
- Please assemble on a clean soft surface to avoid damage.

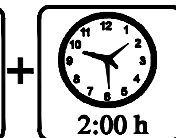
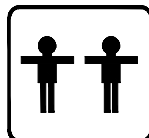
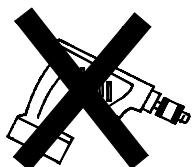

Tools Required

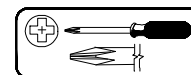

(Not Included)

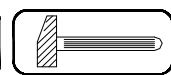

(Not Included)

IMPORTANT:

PLEASE READ INSTRUCTION BEFORE STARTING THE ASSEMBLY

Detail View - BUNK HOUSE BED + SLIDE

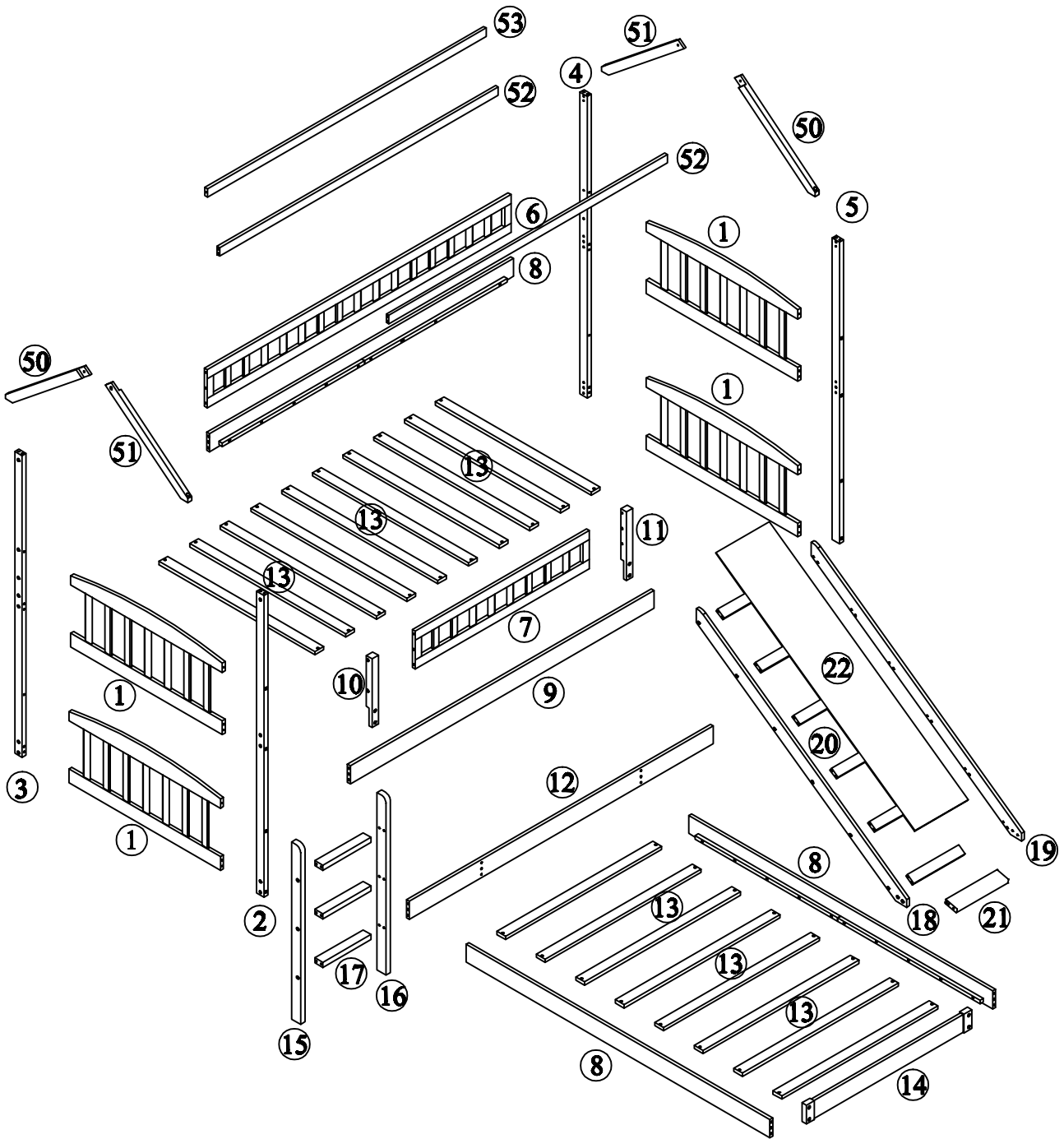

Identifying the Hardware - Identify the hardware using the illustrations below.

Part List—WF281675

1

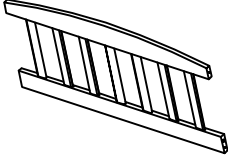



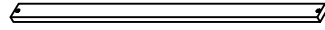

Headboard - 4pc

13

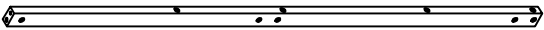

Bed board - 18pc

Part List—WF281676

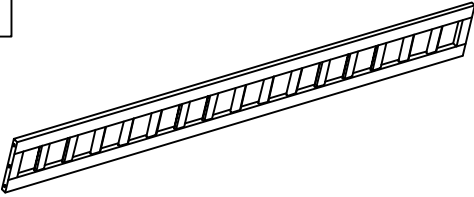
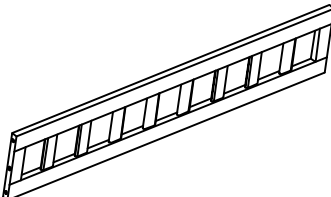
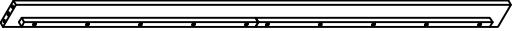
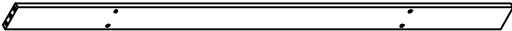
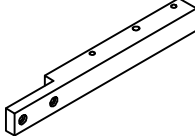
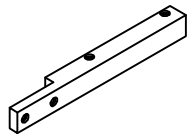
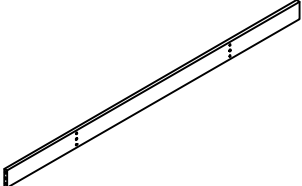
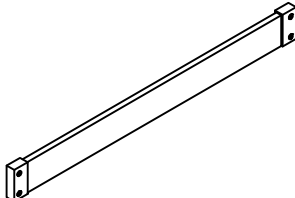
<p>2</p>  <p>Left front bed column- 1pc</p>	<p>3</p>  <p>Left rear bed column - 1pc</p>
<p>4</p>  <p>Right rear bed column - 1pc</p>	<p>5</p>  <p>Right front bed column- 1pc</p>
<p>6</p>  <p>Back guard rail frame - 1pc</p>	<p>7</p>  <p>Front guard rail frame - 1pc</p>
<p>8</p>  <p>Bed side plate - 3pc</p>	<p>9</p>  <p>Bed side plate - 1pc</p>
<p>10</p>  <p>Left front guard rails support - 1pc</p>	<p>11</p>  <p>Right front guard rails support - 1pc</p>
<p>12</p>  <p>Lower bed side plate - 1pc</p>	<p>14</p>  <p>Foot board - 1pc</p>

15

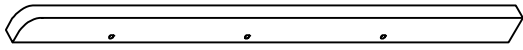

Bed ladder column - 1pc

16

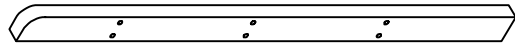

Bed ladder column - 1pc

17

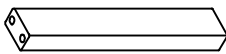

Step of bed ladder - 3pc

18

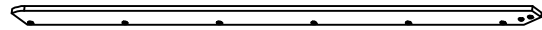

Slide column - 1pc

19



Slide column - 1pc

20

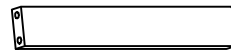

Slide support wood - 6pc

21

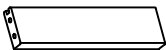

Slide baffle - 1pc

22

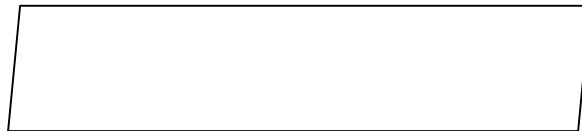

Skate - 1pc

50

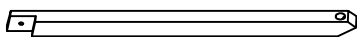

Roof connecting bar - 2pcs

51

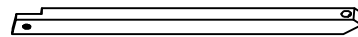

Roof connecting bar - 2pcs

52

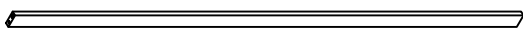





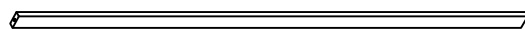





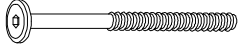

Roof connecting bar - 2pcs

53

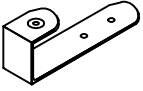

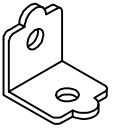
Roof connecting bar - 1pcs



Hardware List—WF281675

<p>A</p>  <p>$\varnothing 13 \times 1/4" \times 80 \text{mm}$</p> <p>Hex-Head bolts(36pcs)</p>	<p>B</p>  <p>$\varnothing 13 \times 1/4" \times 30 \text{mm}$</p> <p>Hex-Head bolts(4pcs)</p>	<p>C</p>  <p>$\varnothing 13 \times 1/4" \times 50 \text{mm}$</p> <p>Hex-Head screw(36pcs)</p>
<p>D</p>  <p>$\varnothing 13 \times 1/4" \times 80 \text{mm}$</p> <p>Hex-Head screw(4pcs)</p>	<p>E</p>  <p>$\varnothing 10 \times 13 \text{mm}$</p> <p>Horizontal-Hole bolts(36pcs)</p>	<p>F</p>  <p>$\varnothing 8 \times \varnothing 4 \times 30 \text{mm}$</p> <p>Round head screw(36pcs)</p>
<p>G</p>  <p>$\varnothing 75 \times 23 \times 24 \text{mm}$</p> <p>Stair hook(4pcs)</p>	<p>H</p>  <p>$\varnothing 7 \times \varnothing 3.5 \times 18 \text{mm}$</p> <p>Flat head screw(12pcs)</p>	<p>I</p>  <p>$20 \times 20 \times 19 \text{mm}$</p> <p>L-Bracket (1pc)</p>
<p>J</p>  <p>$\varnothing 7 \times \varnothing 3.5 \times 15 \text{mm}$</p> <p>Flat head screw(2pcs)</p>	<p>K</p>  <p>4mm</p> <p>Allen key(1pcs)</p>	<p>L</p>  <p>$\varnothing 10 \times 40 \text{mm}$</p> <p>Wood dowel(48pcs)</p>

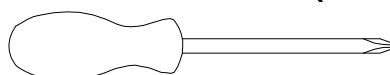
ASSEMBLY TOOLS REQUIRED (NOT INCLUDED)



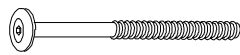

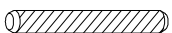
STEP: 1

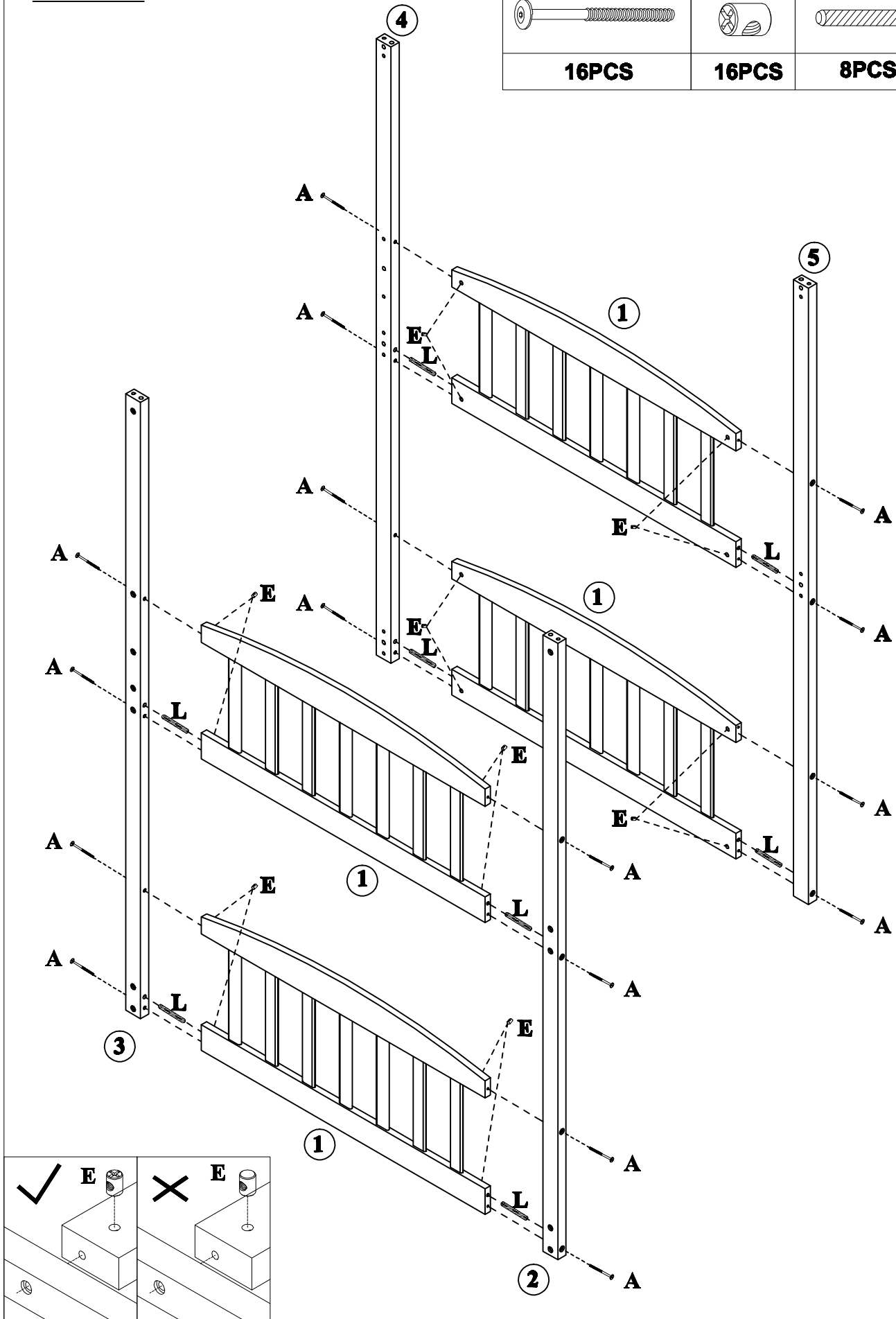
A	E	L
		
16PCS	16PCS	8PCS



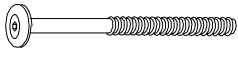
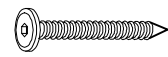

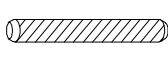
STEP: 2

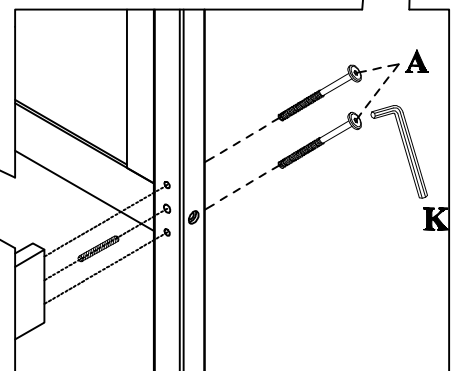
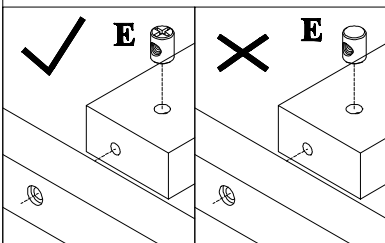
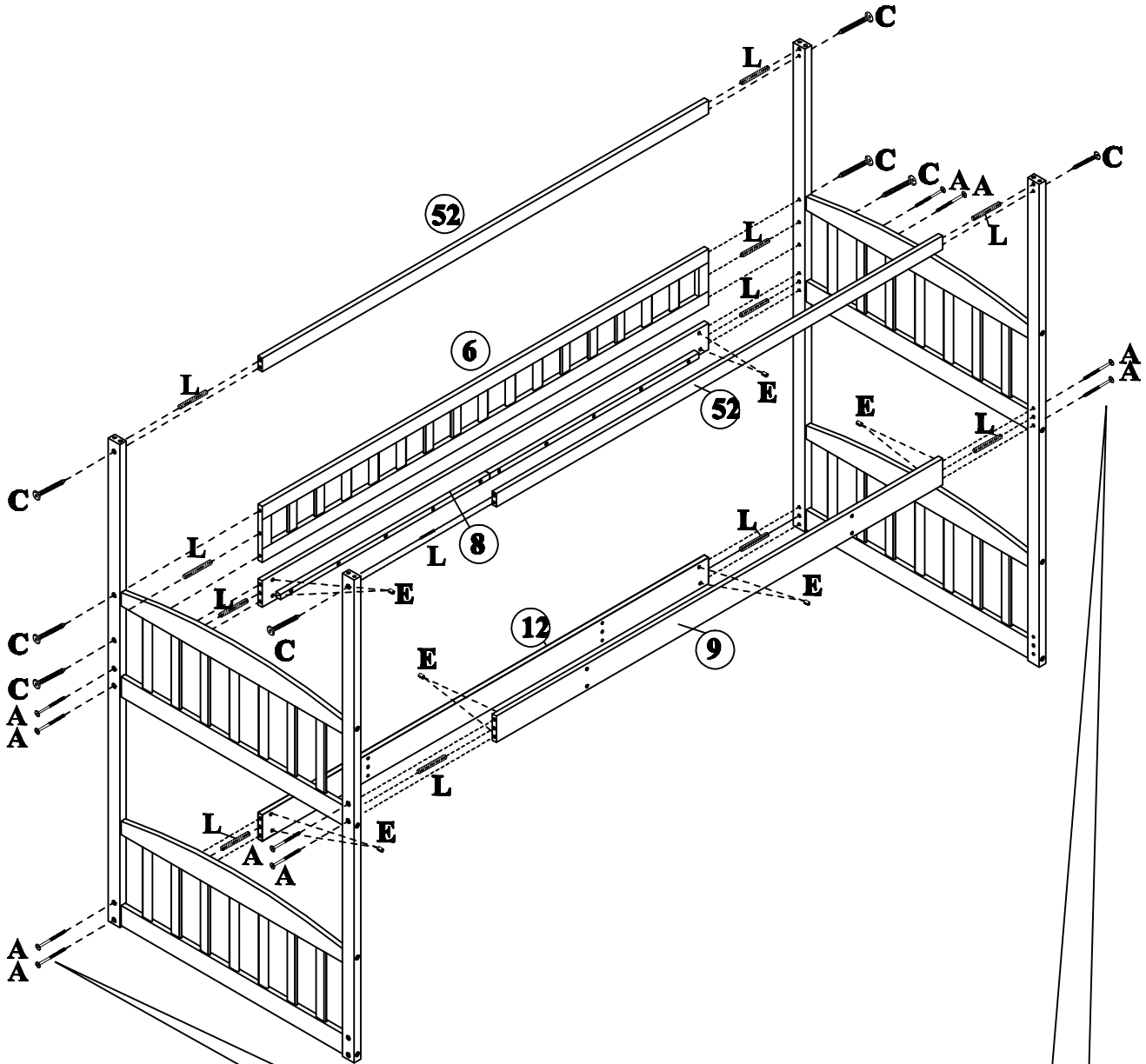
A	C	E	L
			
12PCS	8PCS	12PCS	12PCS



STEP: 3

D	L
	
4PCS	2 PCS

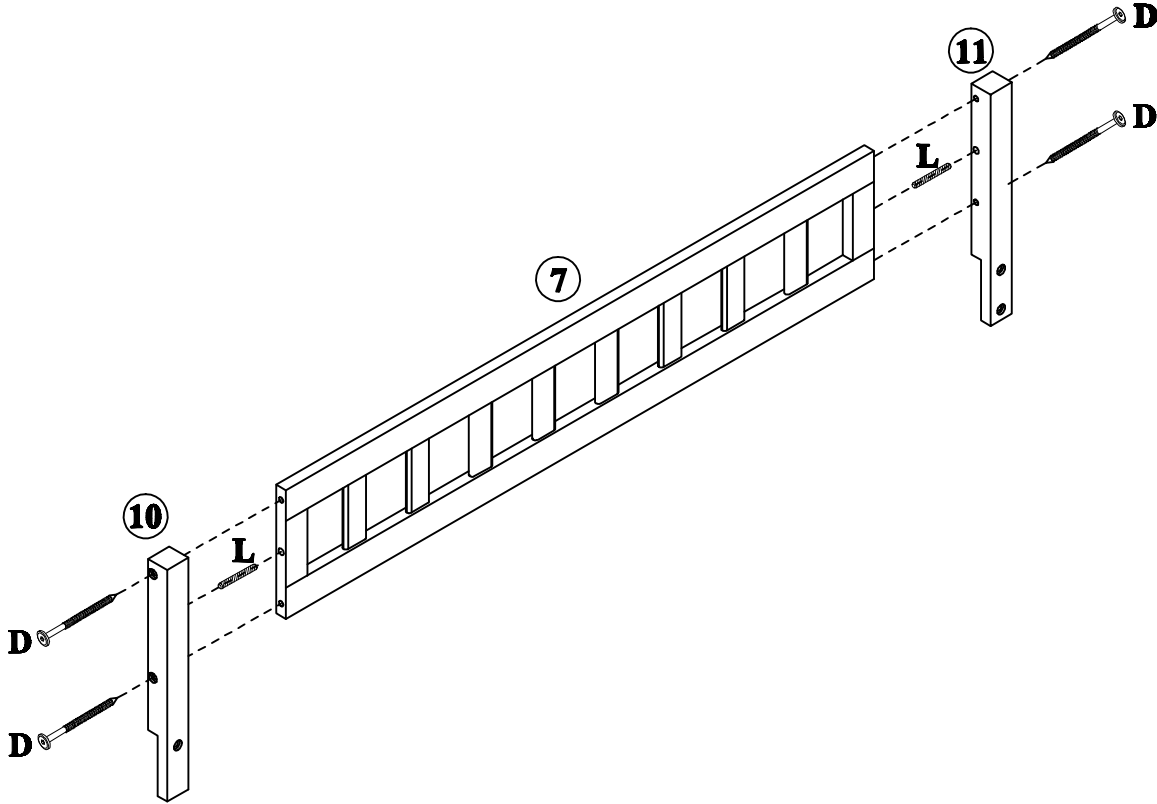

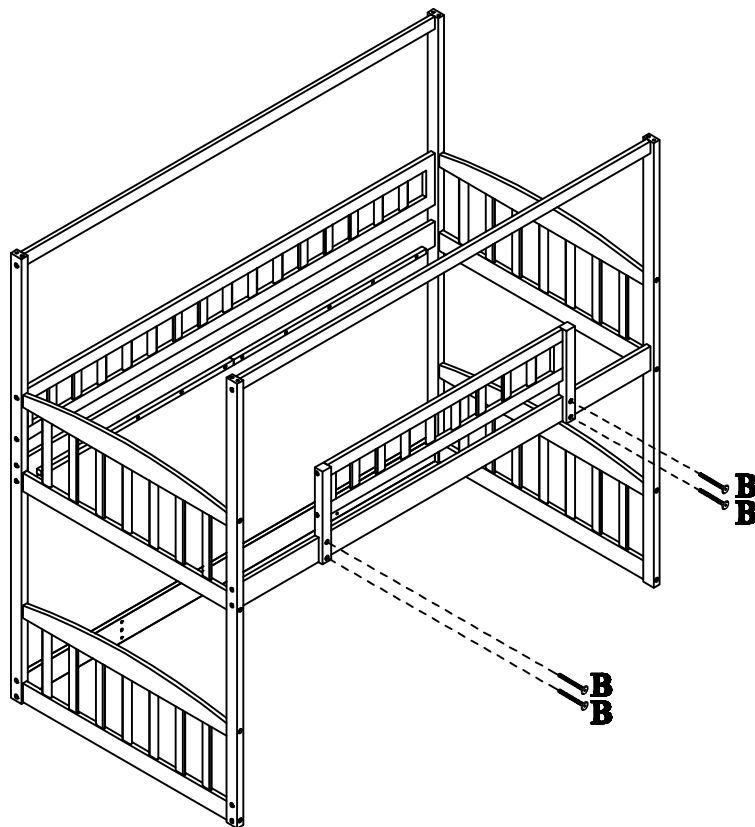

STEP: 4

B

4PCS

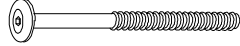
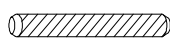

STEP: 5

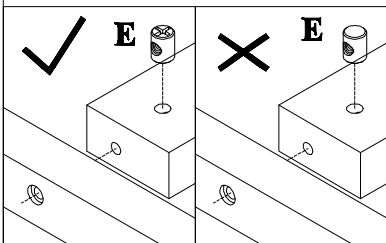
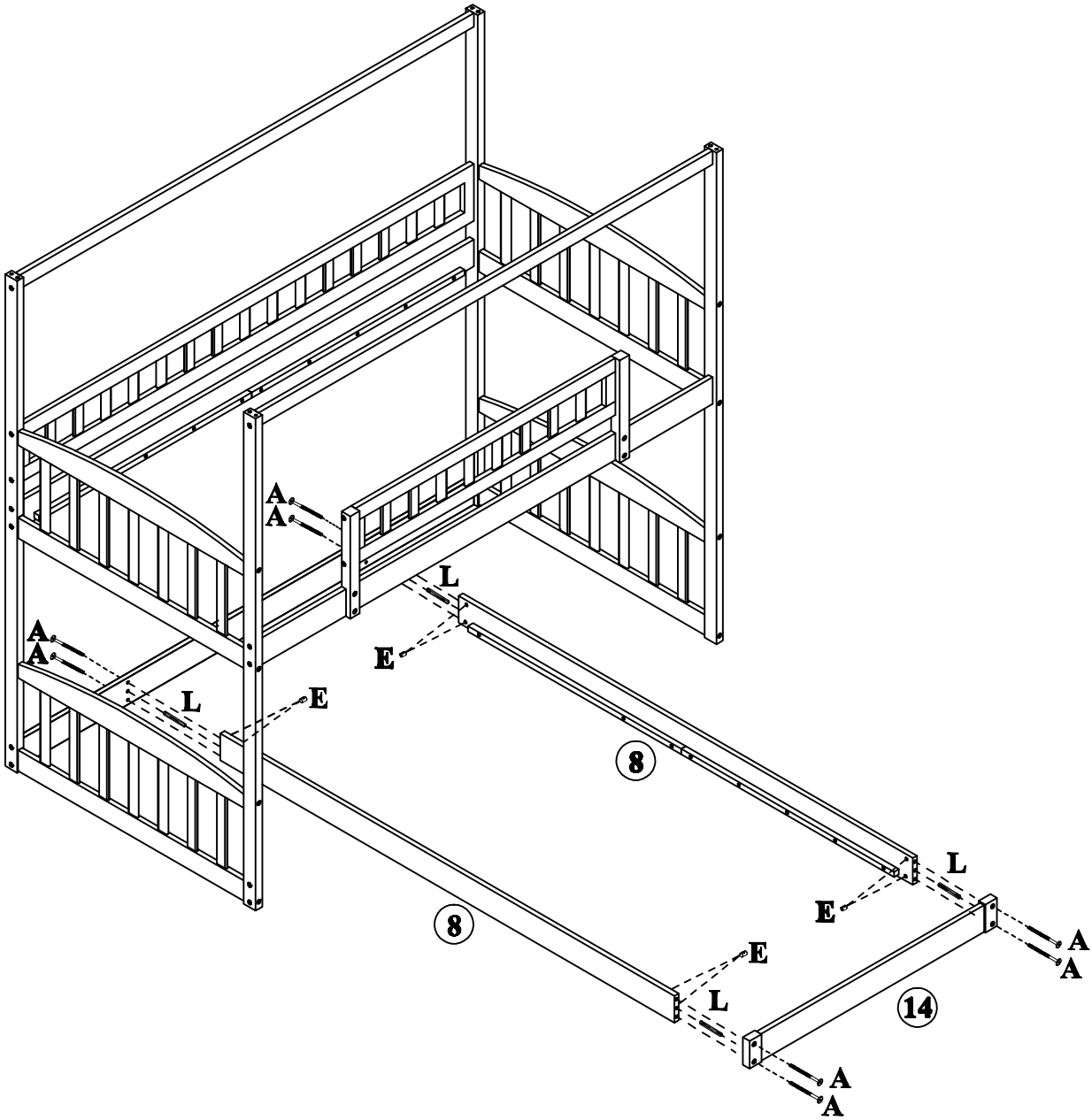
A	L	E
		
8PCS	4PCS	8PCS



STEP: 6

No. 13

Install 10pcs on the top
8pcs on the bottom

F

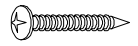

36PCS

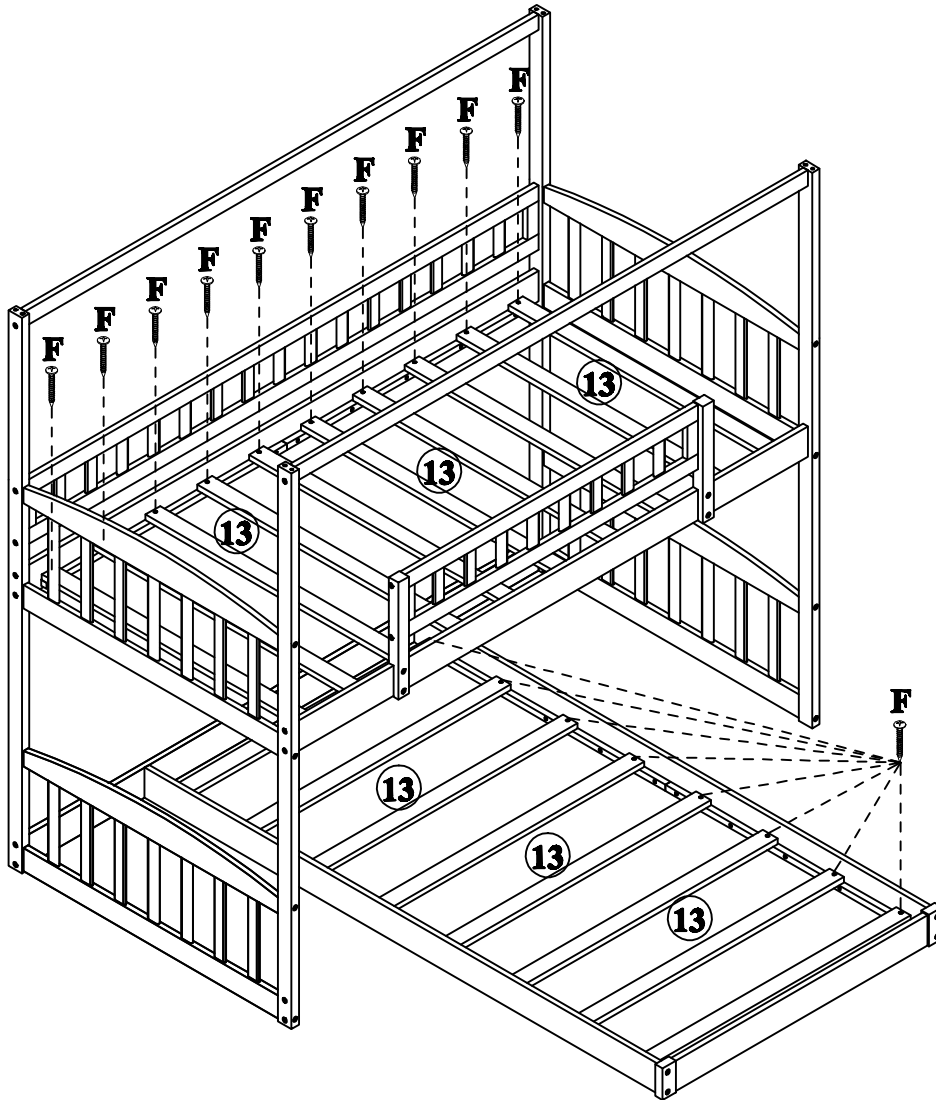

STEP: 7

C



2PCS

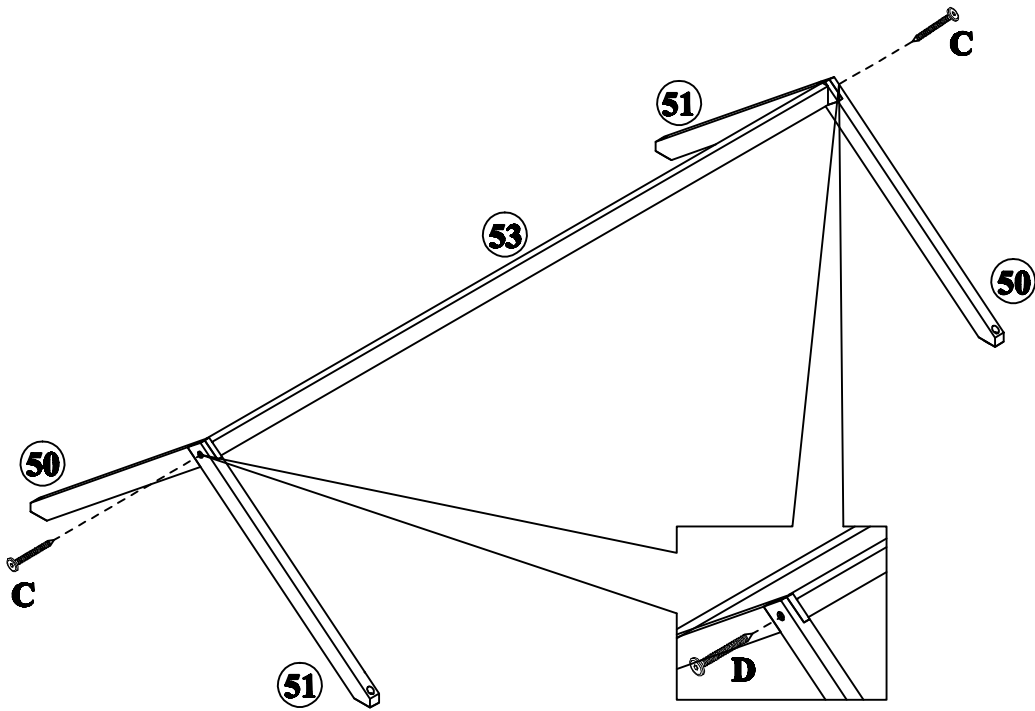

STEP: 8

C



4PCS

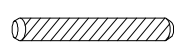

L

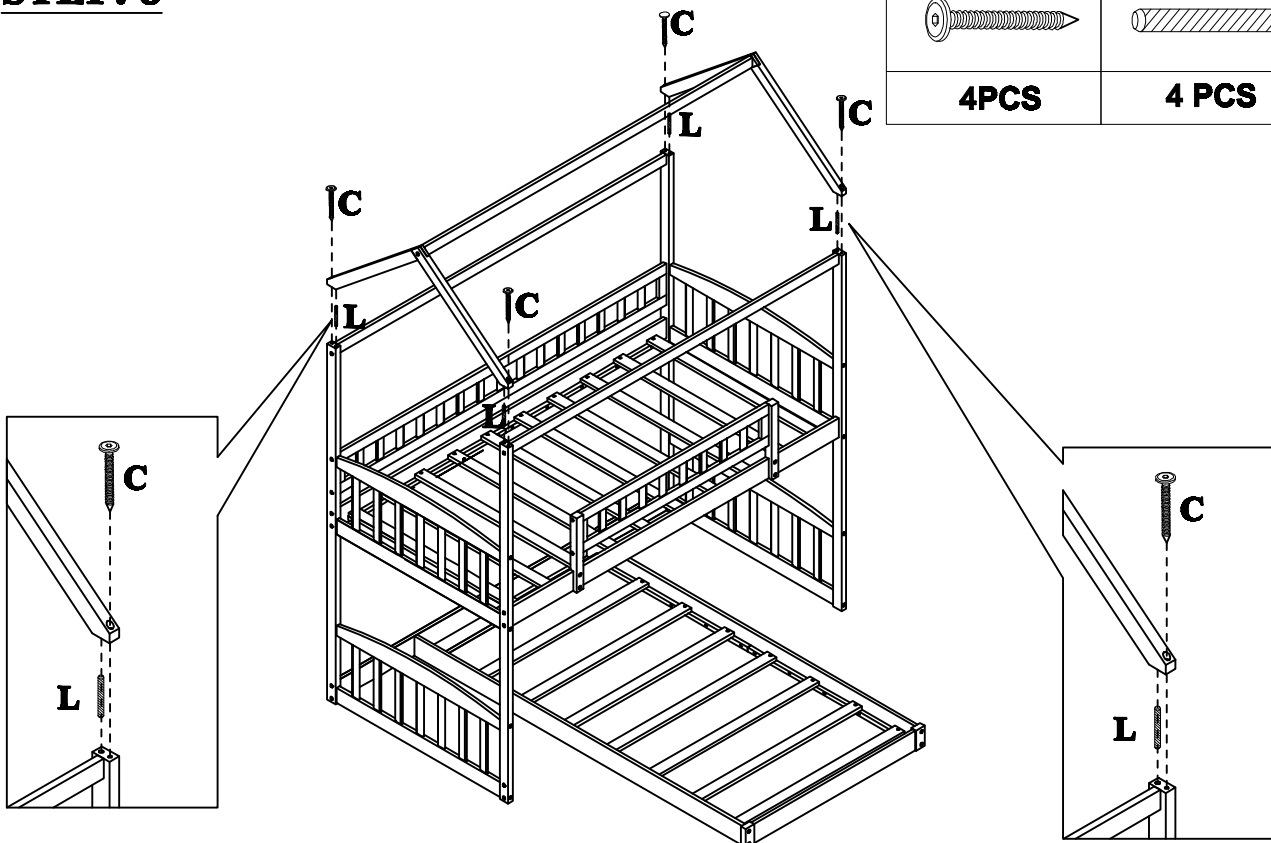

4 PCS



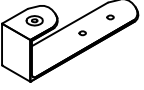

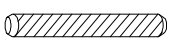
STEP: 9

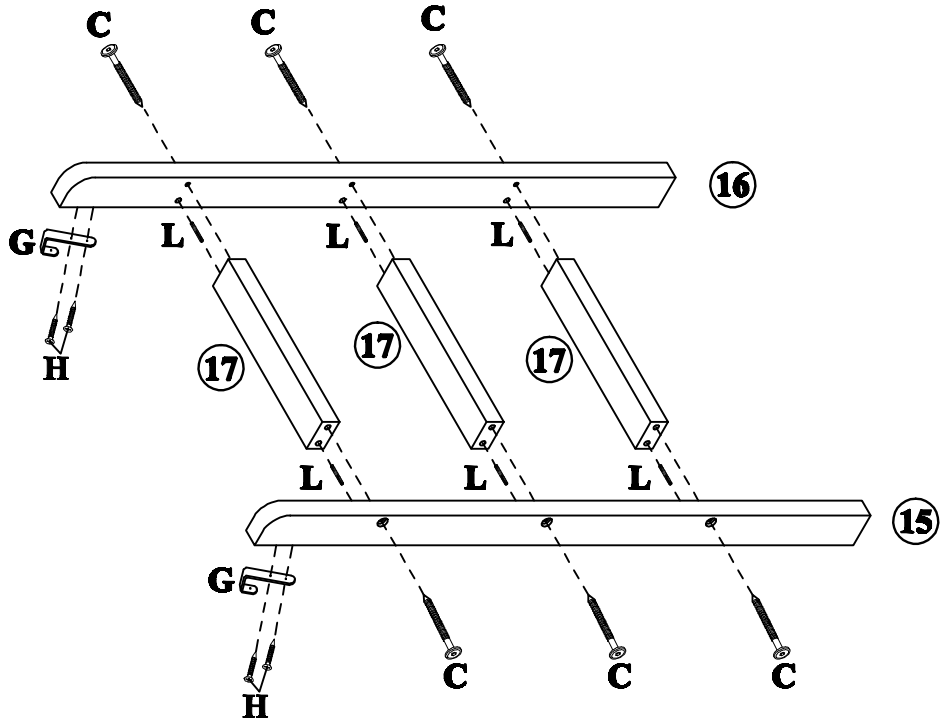
C	G	H	L
			
6PCS	2PCS	4PCS	6PCS



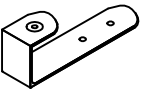

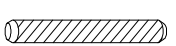
STEP: 10

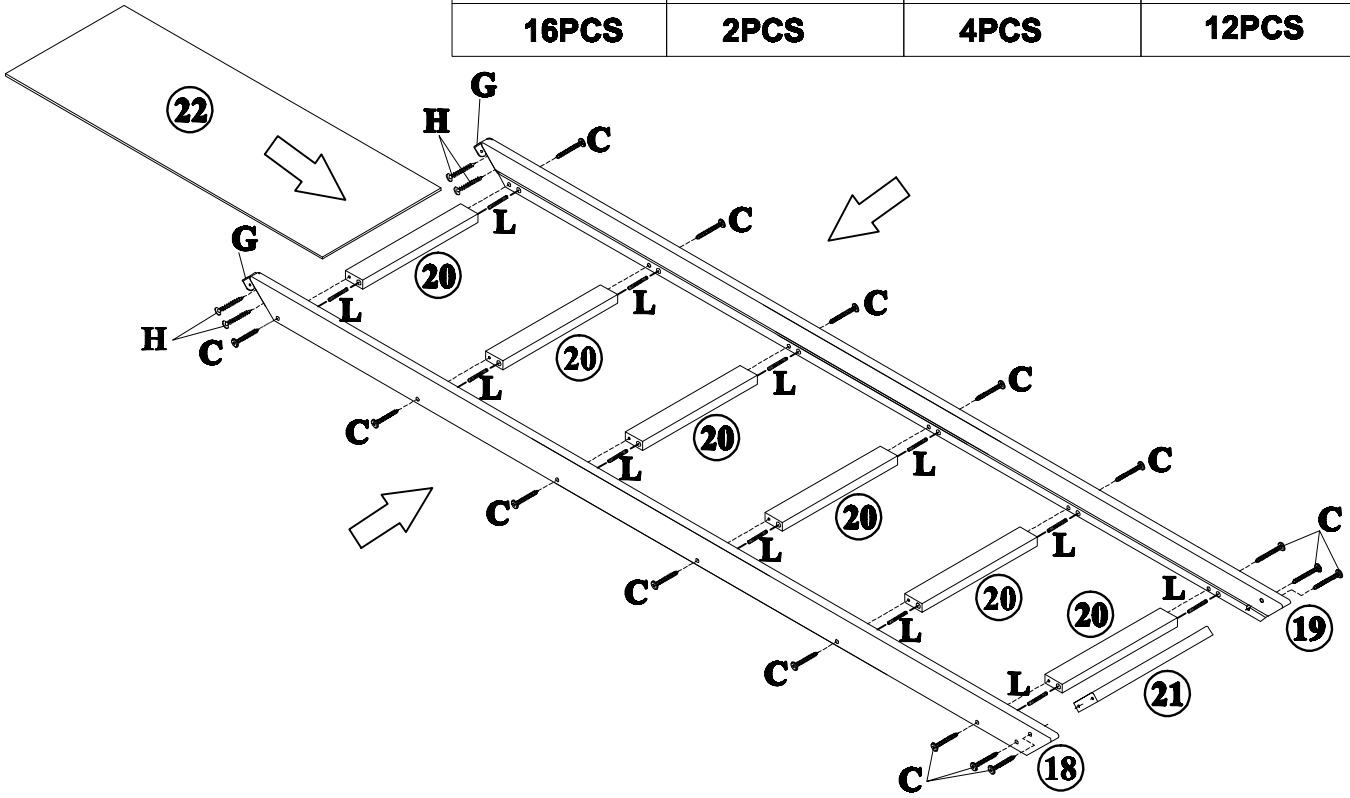
C	G	H	L
			
16PCS	2PCS	4PCS	12PCS

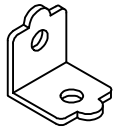

STEP: 11

H	J	I	
			
4PCS	2 PCS	1 PC	

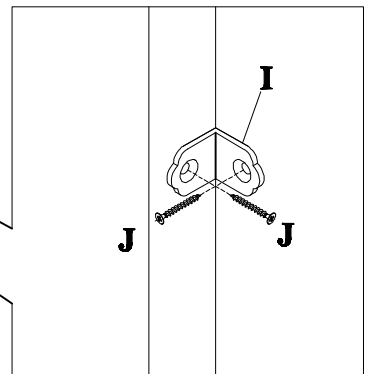
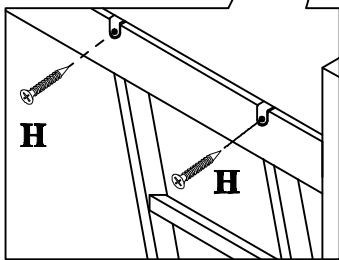
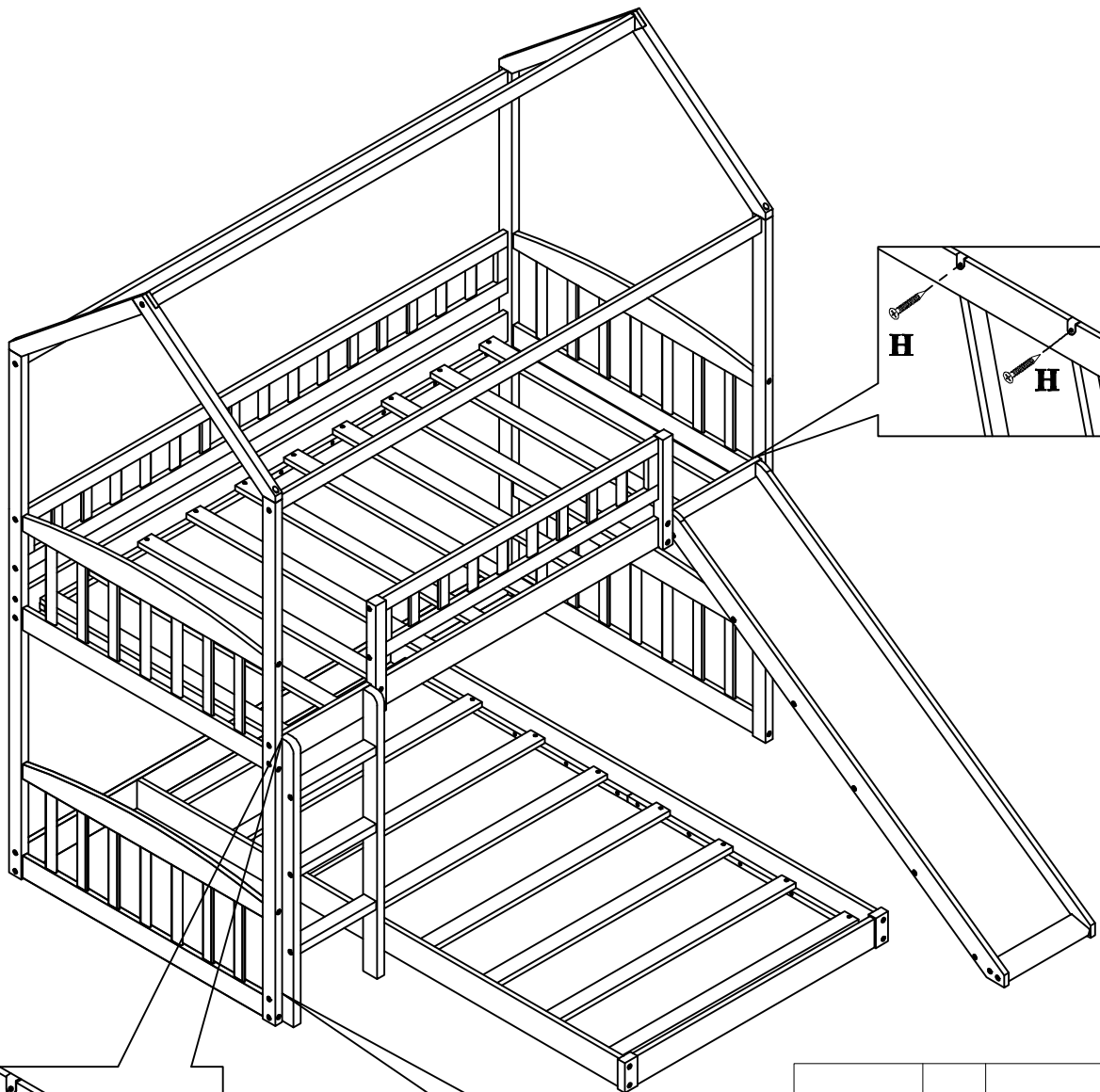

STEP:12

