

ASSEMBLY INSTRUCTIONS

T/T HOUSE BED WITH STAIRS AND SLIDE

Thank you for purchasing this quality product. Be sure to check all packing materials carefully for small parts which may have come loose inside the carton during shipment. Separate, identify and count all parts and hardware. Compare with the parts list to be sure all parts are present.

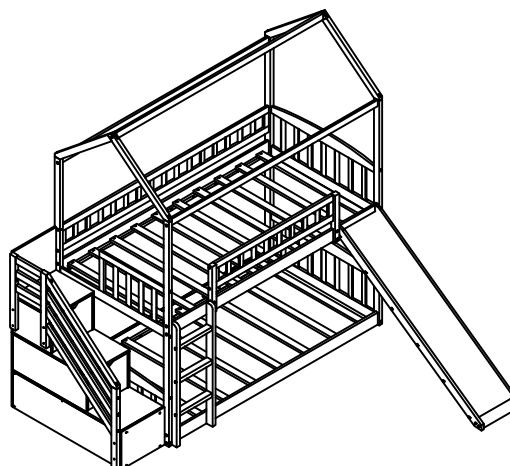

**“DO NOT TIGHTEN SCREWS
UNTIL COMPLETELY ASSEMBLED”**

SIZE OF MATTRESS AND FOUNDATION (SUPPO

This bed is designed to use a twin mattress (37½"-38½"x74-75) and bunkie board (37½ x74). The total thickness must not exceed 8" inches. Do not use mattress without the proper bunkie board of safe foundation.

Note: There must be at least 5" inches from top surface of mattress to top edge or guardrails.

REPLACEMENT PARTS.

Replacement parts, including additional guardrails, may be obtained from place of purchase or original distributor.

SAFETY WARNINGS!

- 1- Follow the information on the warning label appearing on the upper bunk end structure and on the carton. Do not remove warning label from bed.
- 2- Always use the recommended size mattress or mattress support, or both, to help prevent the likelihood of entrapment or falls.
- 3- Surface of mattress must be at least 5 inches below the upper edge of guardrails.
- 4- Do not allow children under 6 years of age to use the upper bunk.
- 5- Prohibit more than one person on upper bunk.
- 6- Periodically check and ensure that the guardrail, ladder and other components are in their proper position free from damage, and that all connectors are tight.
- 7- Do not allow horseplay on or under the bed and prohibit jumping on the bed.
- 8- Always use the ladder for entering and leaving the upper bunk.
- 9- Do not use substitute parts. Contact distributor or dealer for replacement parts.
- 10- Use of a night light may provide added safety precaution for a child using the upper bunk.
- 11- If the bunk bed will be placed next to a wall, the guardrail that runs the full length of the bed should be placed against the wall to prevent entrapment between the bed and the wall.
- 12- Always use guardrails on both long sides of the upper bunk.
- 13- The use of water or sleep flotation mattresses is prohibited.
- 14- Keep these instructions for future reference.
- 15- Strangulation Hazard - Never attach or hang items to any part of the bunk bed that are not designed for use with the bed: for example, but not limited to, hooks, belts, and jump ropes, etc.



IMPORTANT: PLEASE READ INSTRUCTIONS BEFORE STARTING THE ASSEMBLY

ASSEMBLY INSTRUCTIONS

BUNK HOUSE BED WITH STAIRS

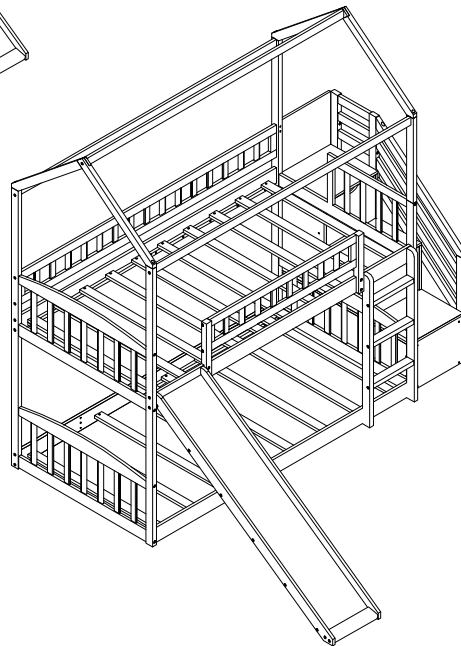
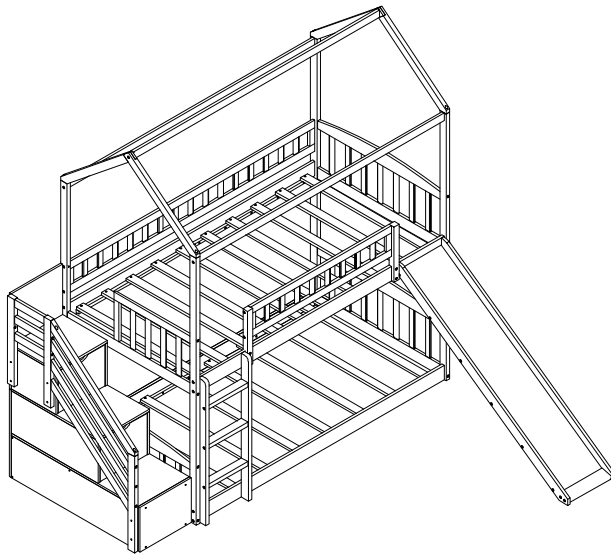

Thank you for purchasing this quality product. Be sure to check all packing material carefully for small parts which may have come loose inside the carton during shipment. Separate, identify and count all parts and hardware.

Compare with the parts list to be sure all parts are present.

"DO NOT TIGHTEN SCREWS UNTIL COMPLETELY ASSEMBLED"

• Use of power tool to assemble this product will invalidate any claim and damage this product making unsafe !!!
• Please assemble on a clean soft surface to avoid damage.

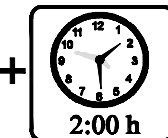
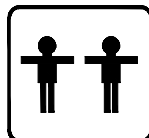
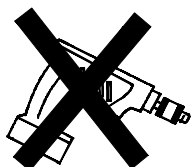

Tools Required

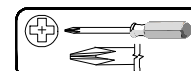

(Not Included)

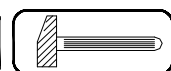

(Not Included)

IMPORTANT:

PLEASE READ INSTRUCTION BEFORE STARTING THE ASSEMBLY

Detail View - T/T HOUSE BED WITH SLIDE

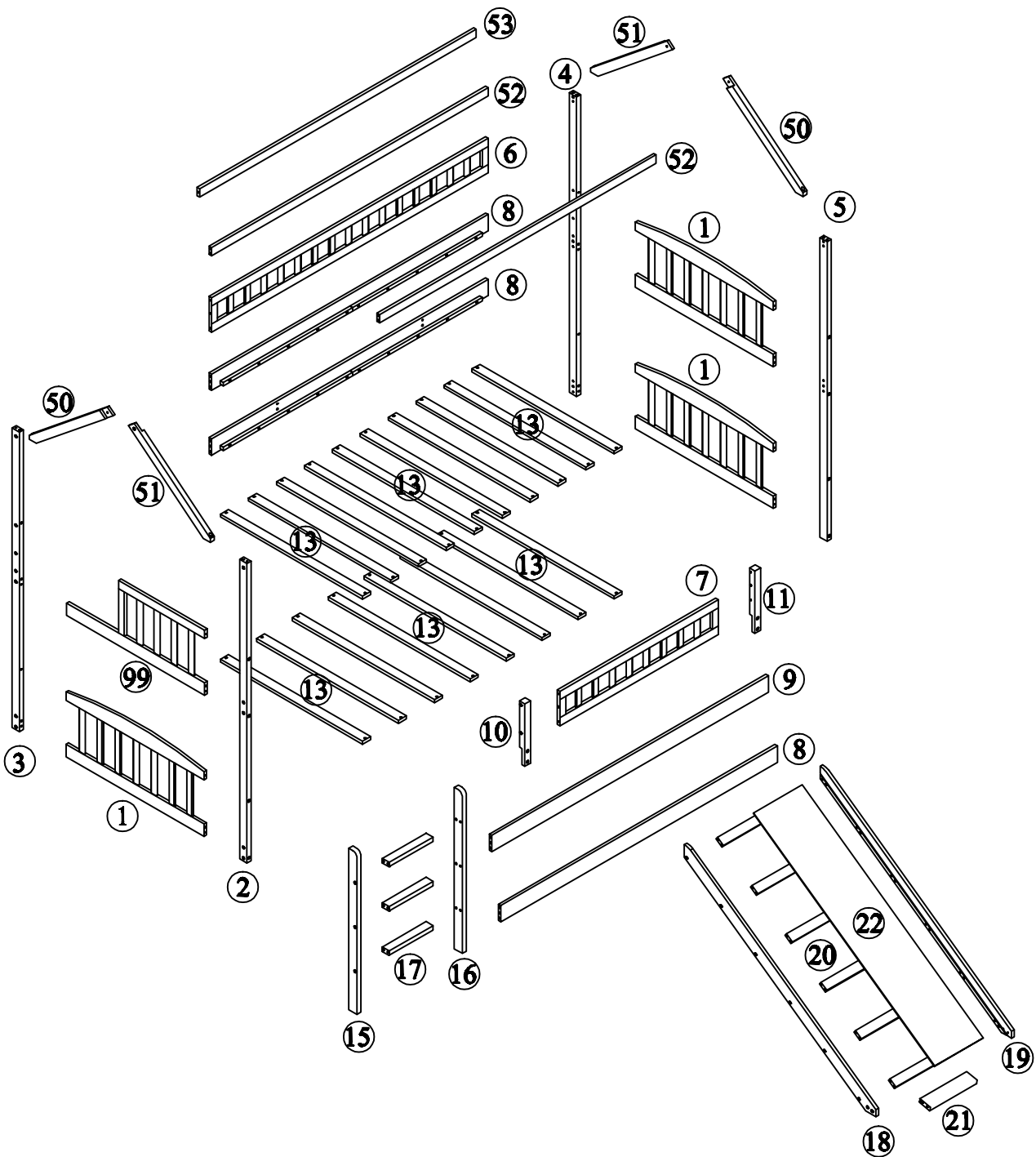

Identifying the Hardware - Identify the hardware using the illustrations below.



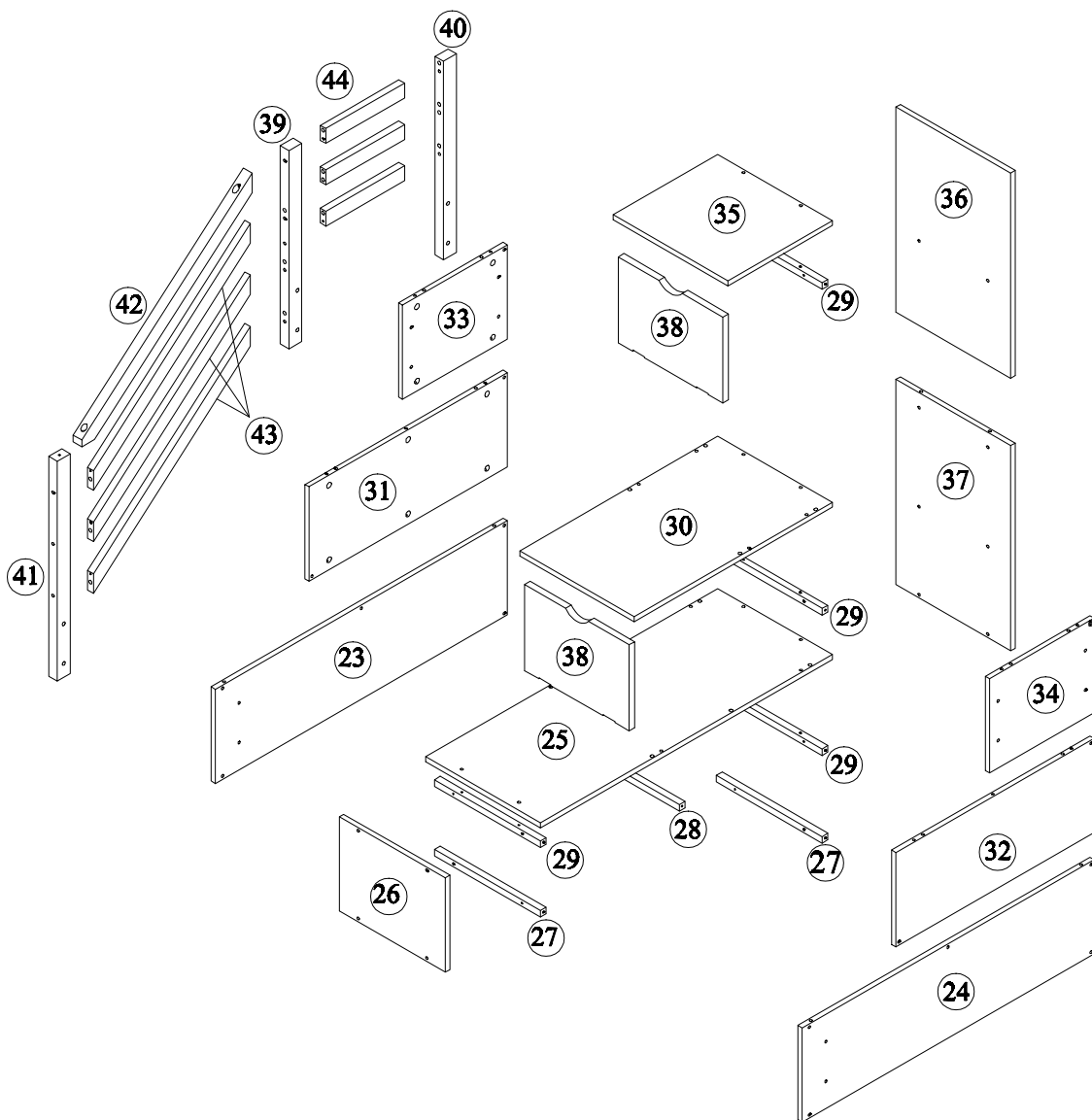

Detail View - STAIRS

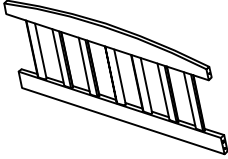
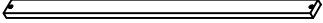
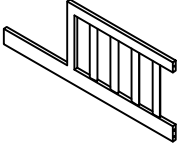

Part List—WF282249

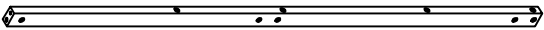
<p>1</p>  <p>Headboard - 3pc</p>	<p>13</p>  <p>Bed board - 18pc</p>
<p>99</p>  <p>Headboard - 1pc</p>	

Part List—WF282250

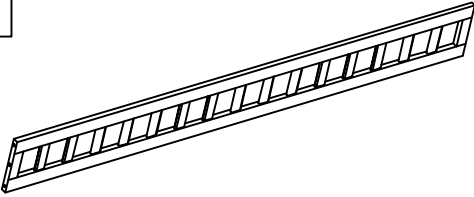
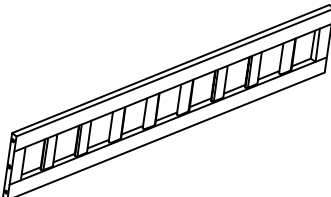
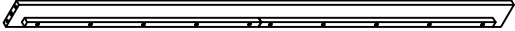
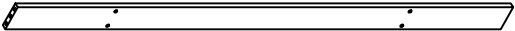
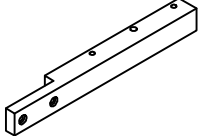
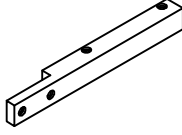
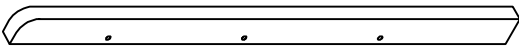
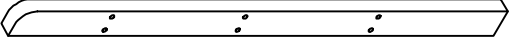
<p>2</p>  <p>Left front bed column- 1pc</p>	<p>3</p>  <p>Left rear bed column - 1pc</p>
<p>4</p>  <p>Right rear bed column - 1pc</p>	<p>5</p>  <p>Right front bed column- 1pc</p>
<p>6</p>  <p>Back guard rail frame - 1pc</p>	<p>7</p>  <p>Front guard rail frame - 1pc</p>
<p>8</p>  <p>Bed side plate - 3pc</p>	<p>9</p>  <p>Bed side plate - 1pc</p>
<p>10</p>  <p>Left front guard rails support - 1pc</p>	<p>11</p>  <p>Right front guard rails support - 1pc</p>
<p>15</p>  <p>Bed ladder column - 1pc</p>	<p>16</p>  <p>Bed ladder column - 1pc</p>

17

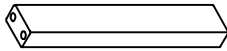

Step of bed ladder - 3pc

18

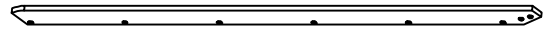

Slide column - 1pc

19

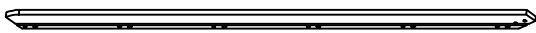

Slide column - 1pc

20



Slide support wood - 6pc

21

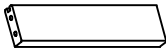

Slide baffle - 1pc

22



Skate - 1pc

50

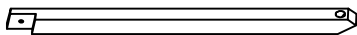

Roof connecting bar - 2pcs

51

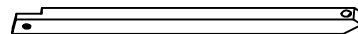

Roof connecting bar - 2pcs

52

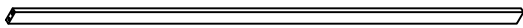



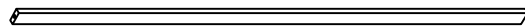

Roof connecting bar - 2pcs

53

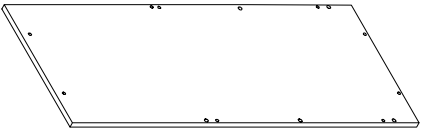
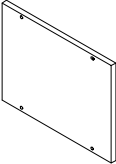
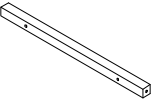
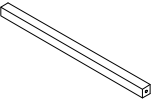
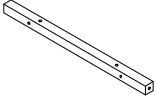
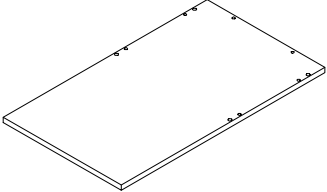
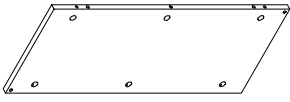

Roof connecting bar - 1pc

Part List—WF282251

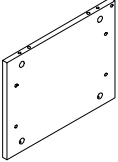
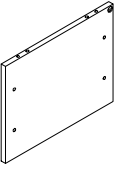
23  Left Side panel- 1pc	24  Right Side panel- 1pc
25  Storage ladder bottom panel- 1pc	26  Storage ladder front panel- 1 pc
27  Storage ladder support - 2pcs	28  Storage ladder support - 1 pc
29  Storage ladder support - 4pcs	30  Storage ladder between panel - 1pc
31  Left Side panel- 1pc	32  Right Side panel- 1pc
33  Left Side panel- 1pc	34  Right Side panel- 1pc

35

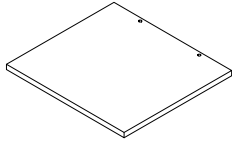

Storage ladder top panel- 1pc

36



Storage ladder top back panel - 1pc

37

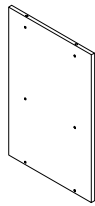

Storage ladder bottom back panel - 1pc

38

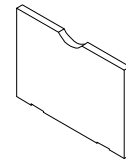

Storage ladder door panels- 2pcs

39

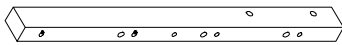

Storage ladder support- 1pc

40

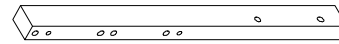

Storage ladder support - 1pc

41

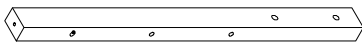

Storage ladder support- 1pc

42

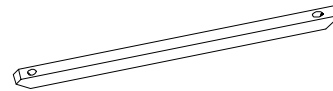

Storage ladder support - 1pc

43

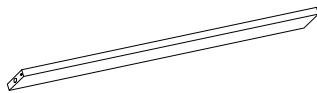





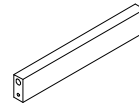





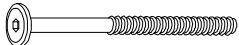

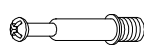

Storage ladder supports - 3pcs

44

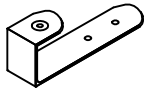
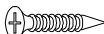
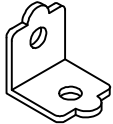
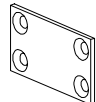
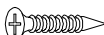
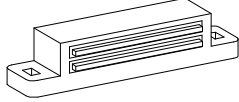

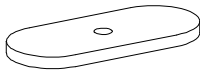
Storage ladder supports- 3pcs



Hardware List—WF282249

A  $\phi 13 \times 1/4" \times 80 \text{mm}$ Hex-Head bolts(31pcs)	B  $\phi 13 \times 1/4" \times 30 \text{mm}$ Hex-Head bolts(4pcs)	C  $\phi 13 \times 1/4" \times 30 \text{mm}$ Hex-Head screw(40pcs)
D  $\phi 13 \times 1/4" \times 50 \text{mm}$ Hex-Head screw(38pcs)	E  $\phi 13 \times 1/4" \times 80 \text{mm}$ Hex-Head screw(16pcs)	F  $\phi 10 \times 13 \text{mm}$ Horizontal-Hole bolts(31pcs)
G  $\phi 6 \times 35 \text{mm}$ Three in one bolts(26pcs)	H  $\phi 14.5 \times 12 \text{mm}$ Three in one lock(26pcs)	I  $\phi 8 \times \phi 4 \times 30 \text{mm}$ Round head screw(36pcs)
J  $\phi 75 \times 23 \times 24 \text{mm}$ Stair hook(4pcs)	K  $\phi 7 \times \phi 3.5 \times 18 \text{mm}$ Flat head screw(12pcs)	L  $20 \times 20 \times 19 \text{mm}$ L-Bracket (1pc)
M  $50 \times 31 \times 2 \text{mm}$ Connecting iron sheet(2pcs)	N  $\phi 7 \times \phi 3.5 \times 15 \text{mm}$ Flat head screw(10pcs)	O  Door magnet(2pcs)
P  Round head screw(4pcs)	Q  Magnetic iron sheet(2pcs)	R  $\phi 6 \times \phi 3 \times 12 \text{mm}$ Flat head screw(10pcs)
S  4mm Allen key(1pcs)	T  $\phi 10 \times 40 \text{mm}$ Wood dowel(59pcs)	U  $\phi 8 \times 30 \text{mm}$ Wood dowel(22pcs)

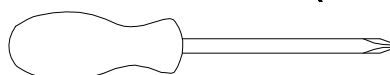
ASSEMBLY TOOLS REQUIRED (NOT INCLUDED)



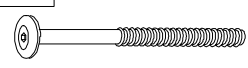

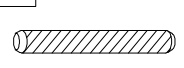
STEP: 1

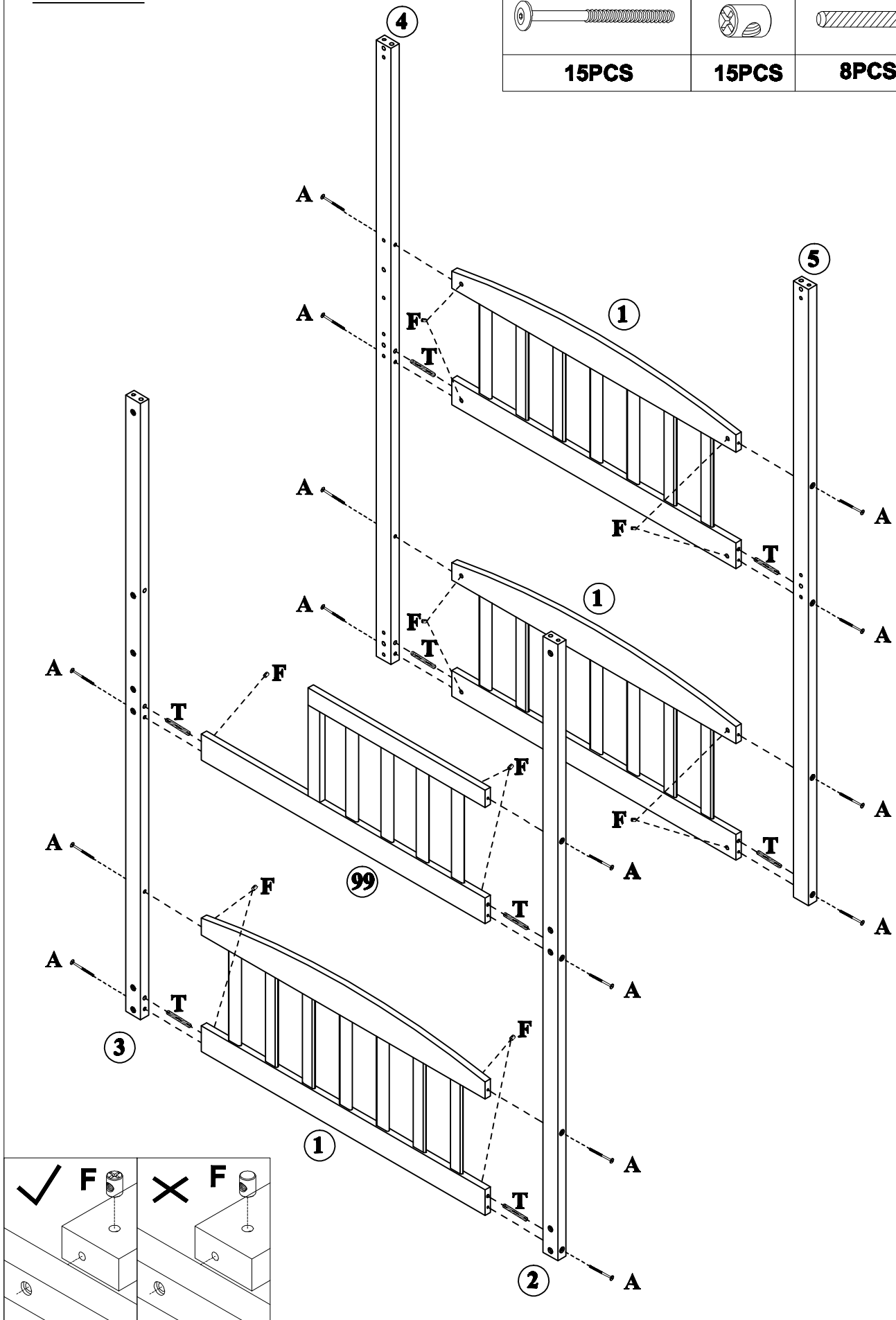
A	F	T
		
15PCS	15PCS	8PCS



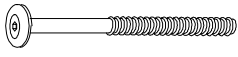
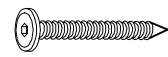

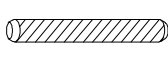
STEP: 2

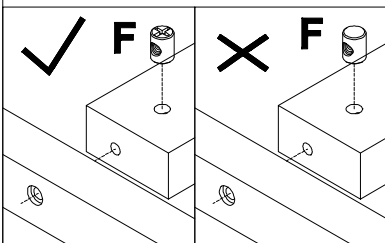
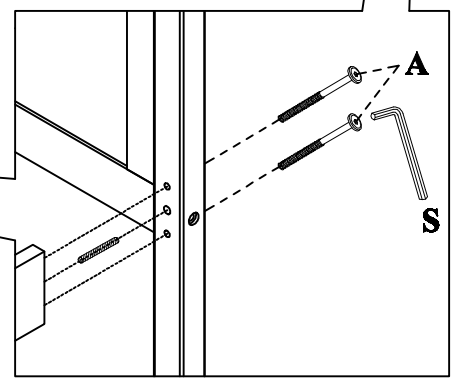
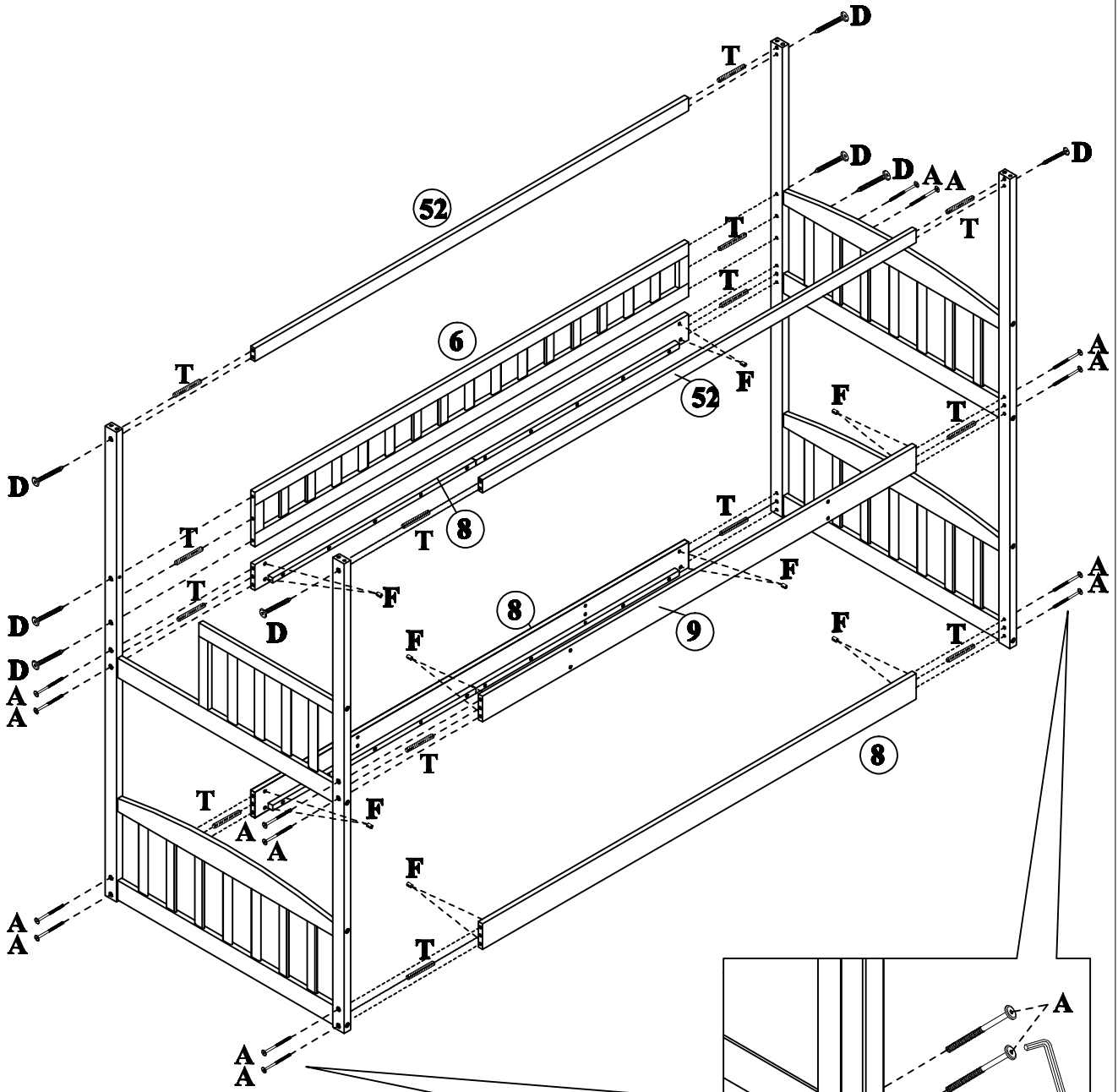
A	D	F	T
			
16PCS	8PCS	16PCS	14PCS



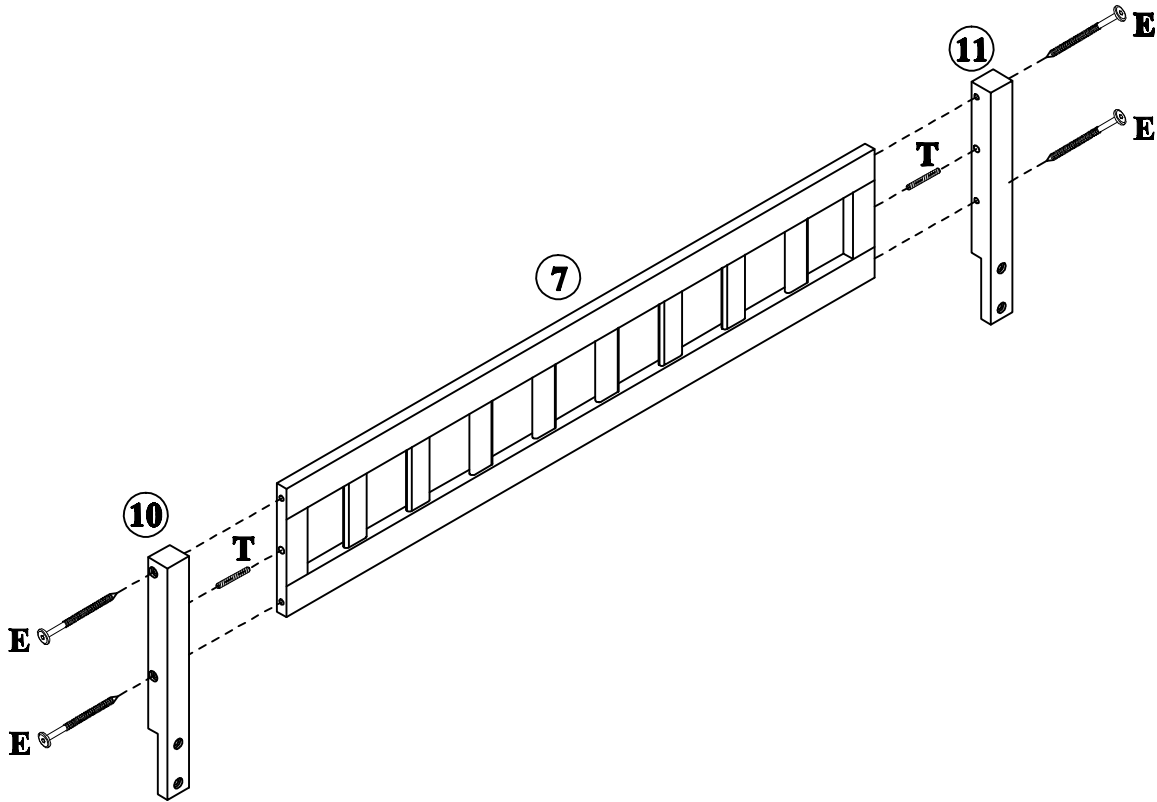

STEP: 3

E		T	
	4PCS		2 PCS



STEP: 4

No. 13
Install 10pcs on the top
8pcs on the bottom

I		B	
	36PCS		4PCS

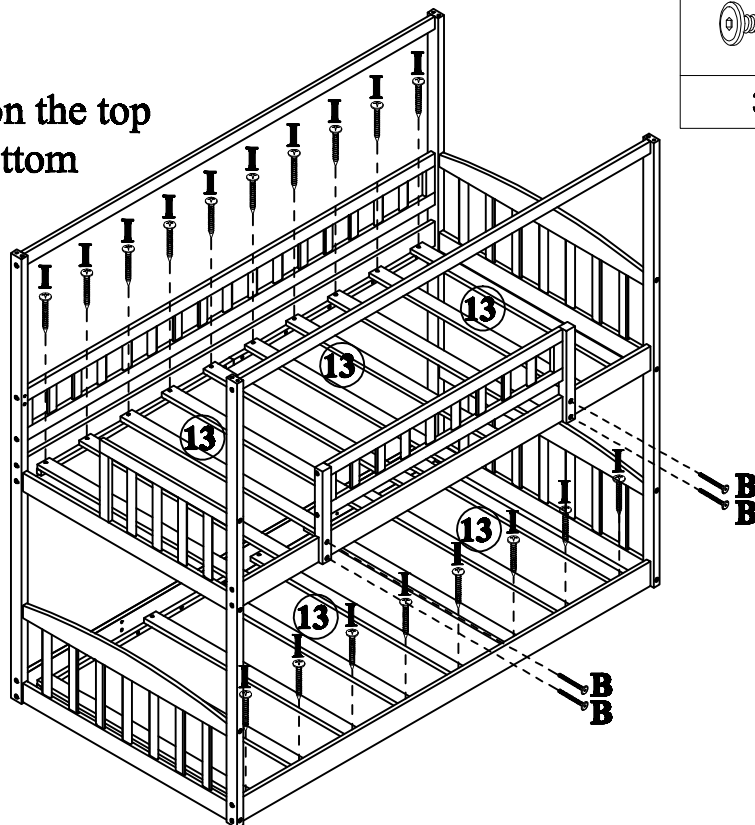

STEP: 5

D

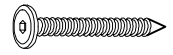

2PCS

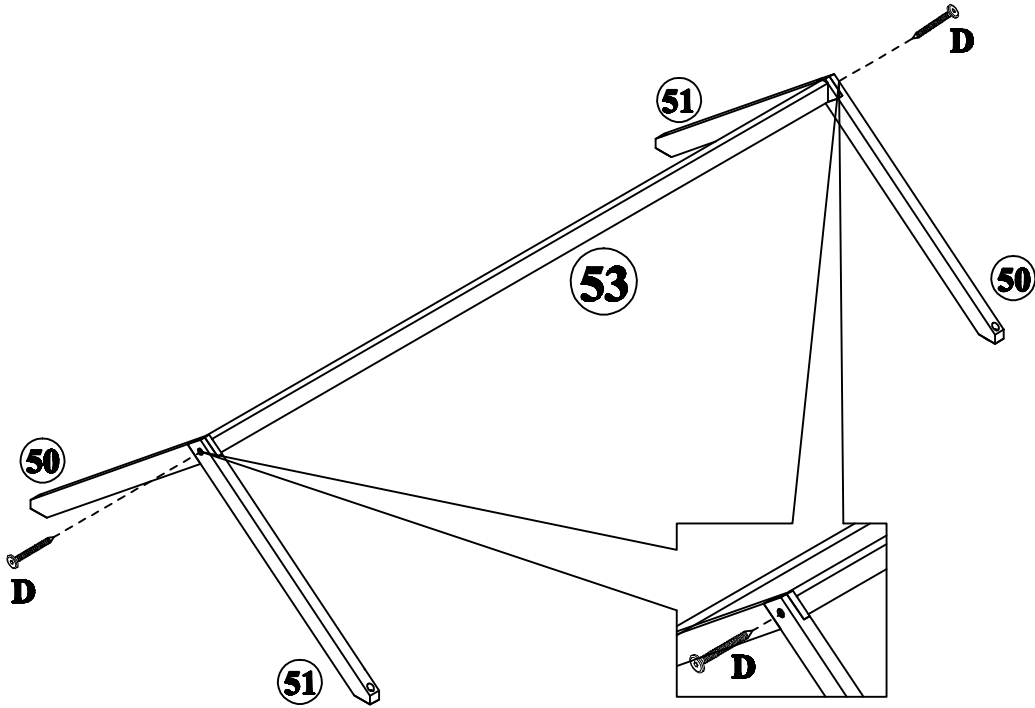

STEP: 6

D



4PCS

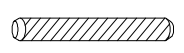

T

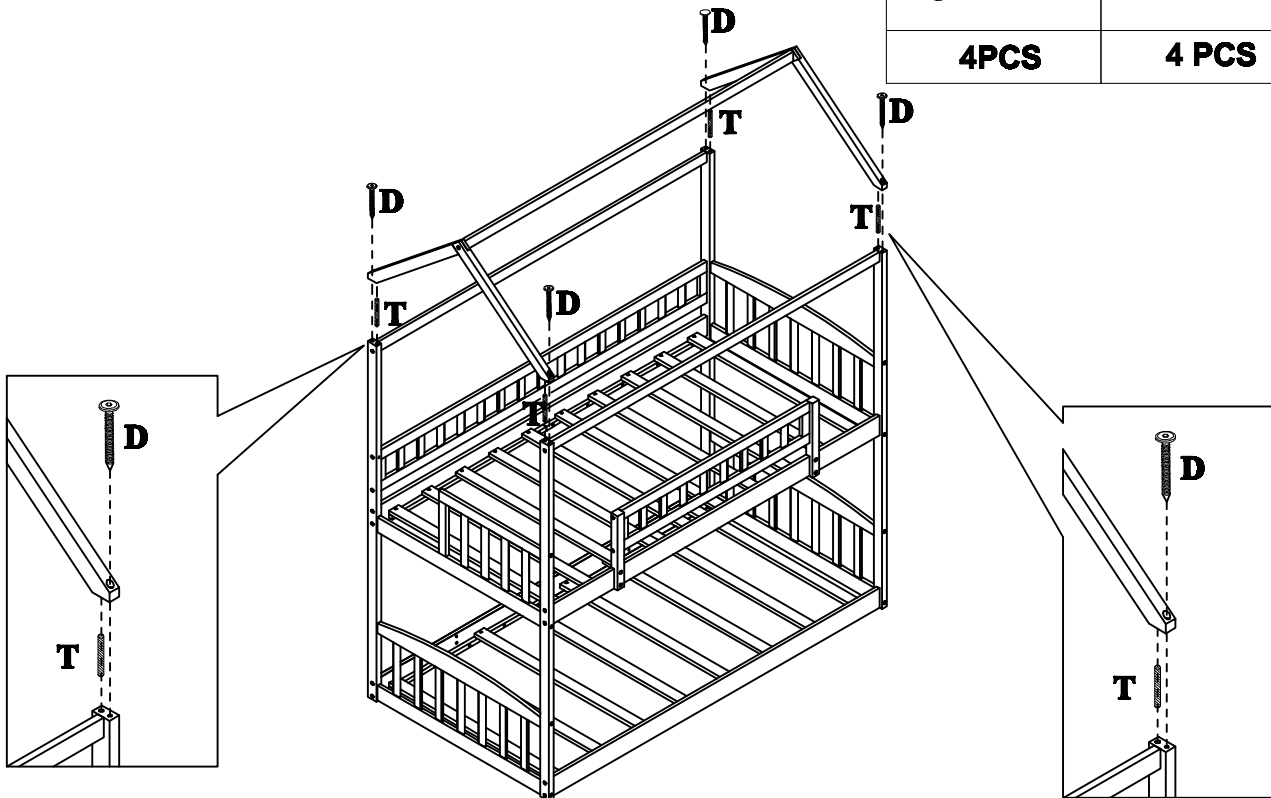

4 PCS



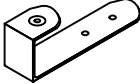

STEP: 7

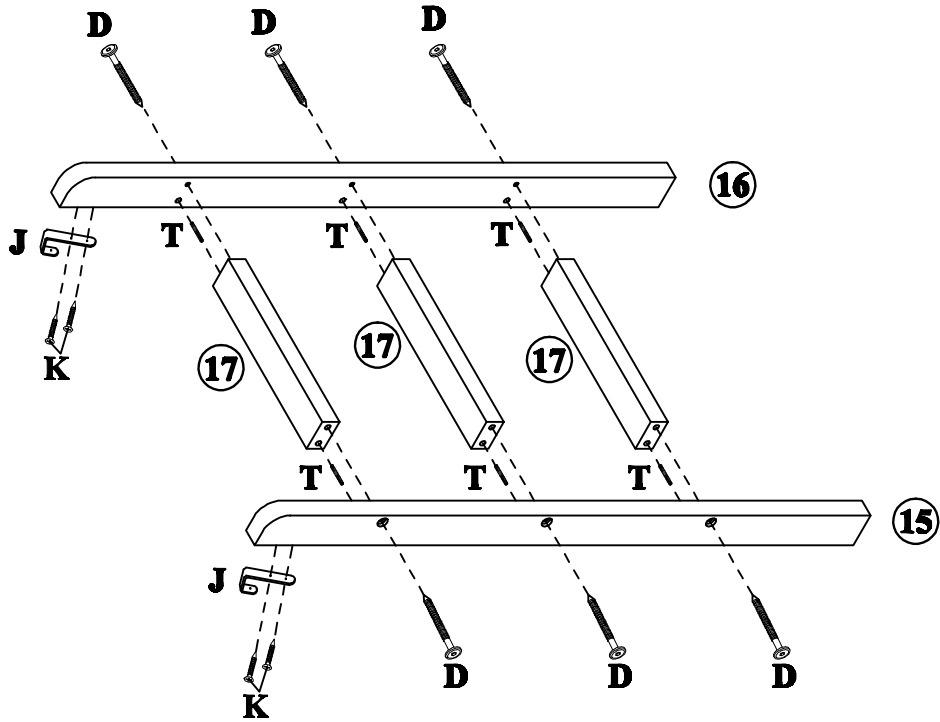
K	J	D	T
			
4PCS	2PCS	6PCS	6PCS

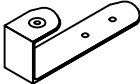

STEP: 8

K	J	D	T
			
4PCS	2PCS	16PCS	12PCS

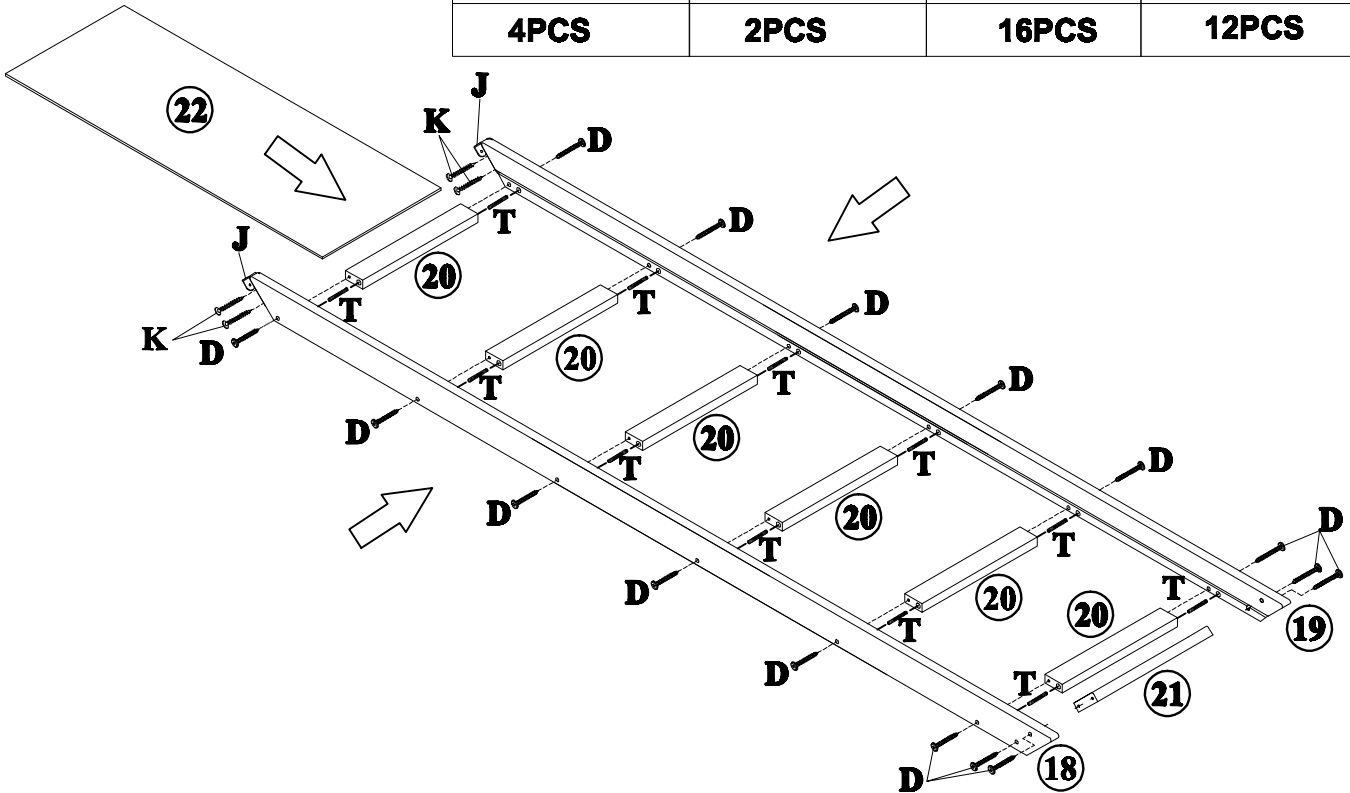

STEP: 9

K



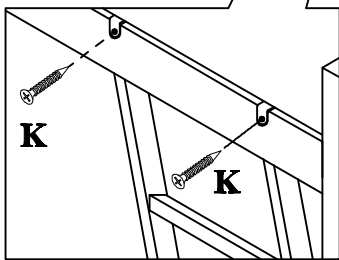
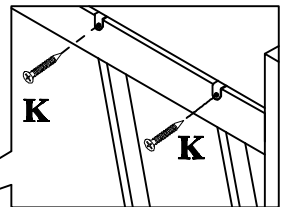
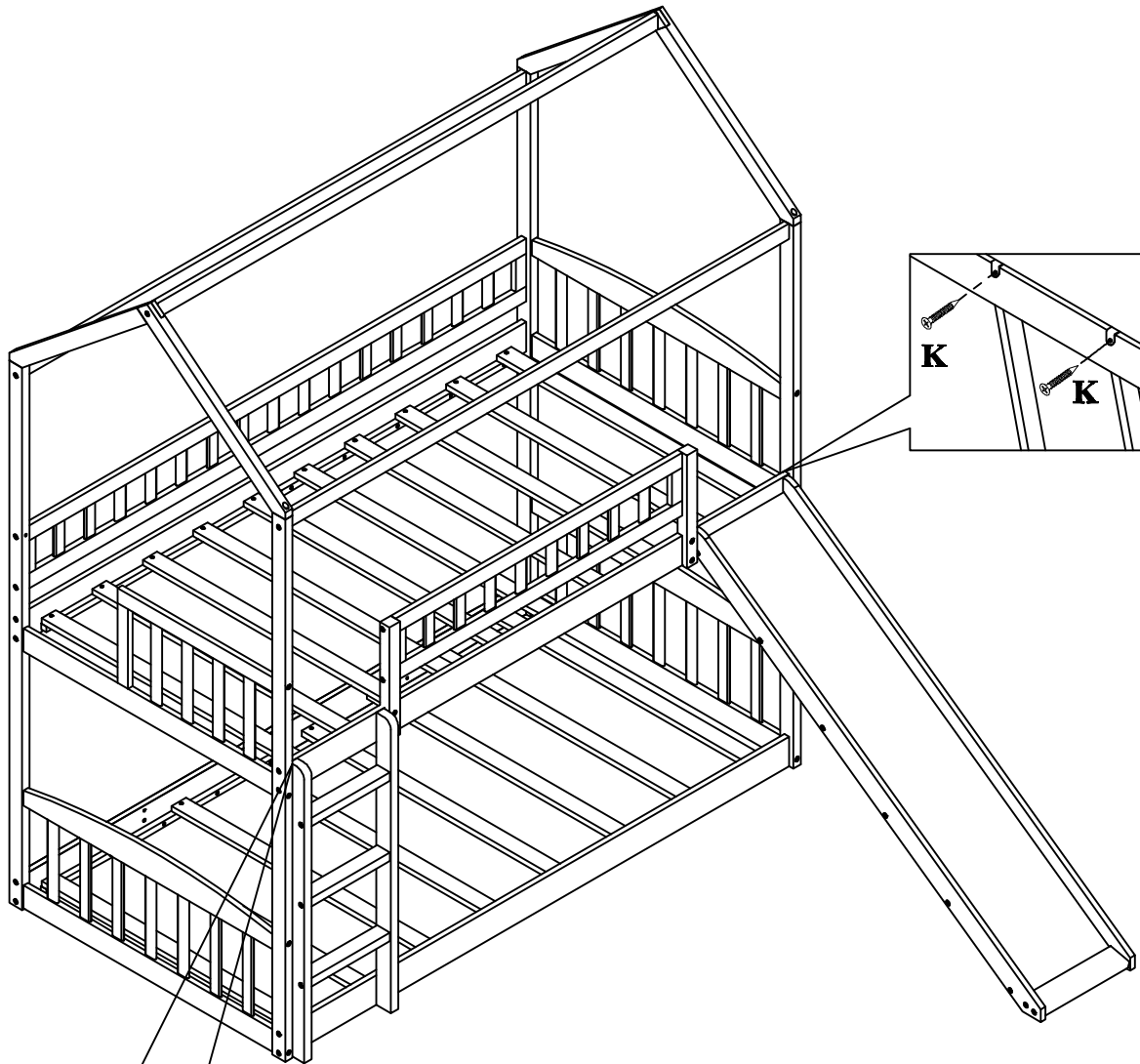

4PCS

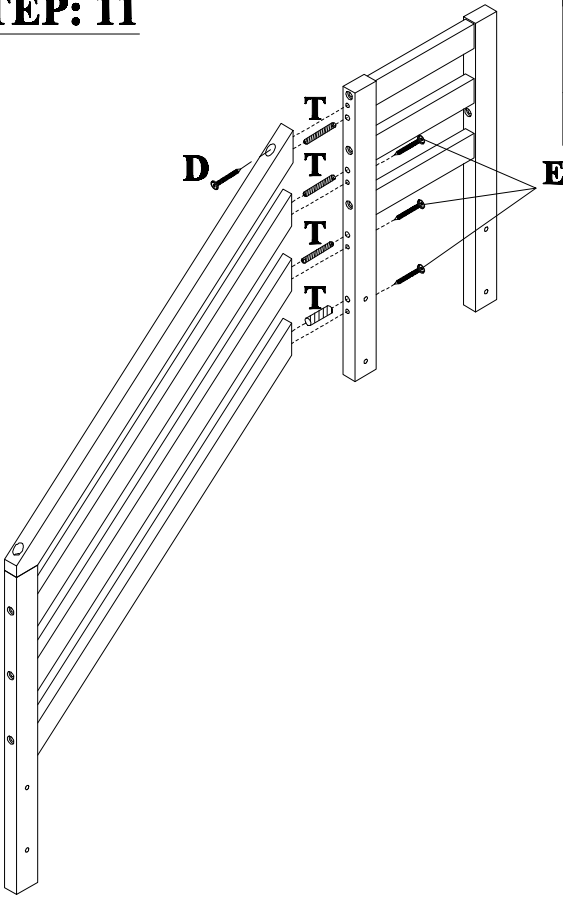

STEP: 11

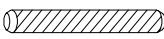

T	D	E
		
4 PCS	1 PCS	3 PCS

STEP: 12

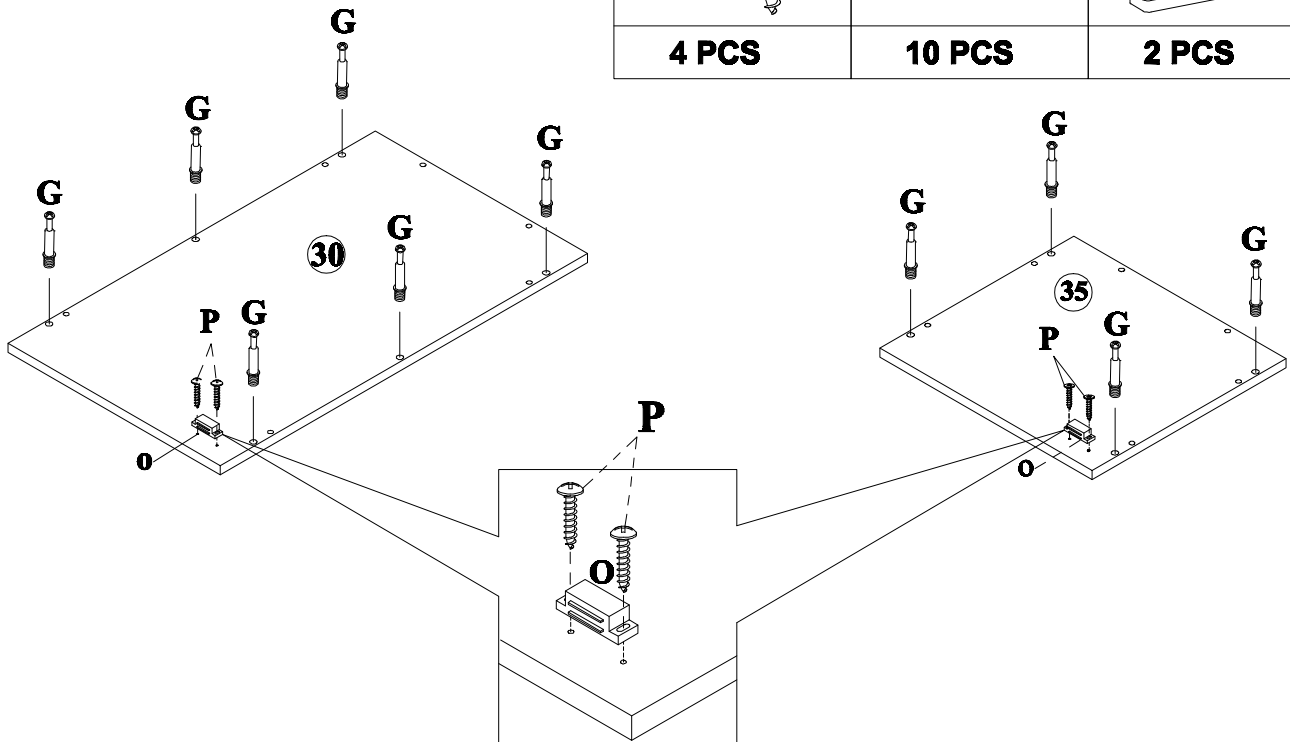

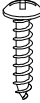
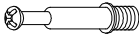
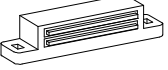
P	G	O
		
4 PCS	10 PCS	2 PCS

STEP: 13

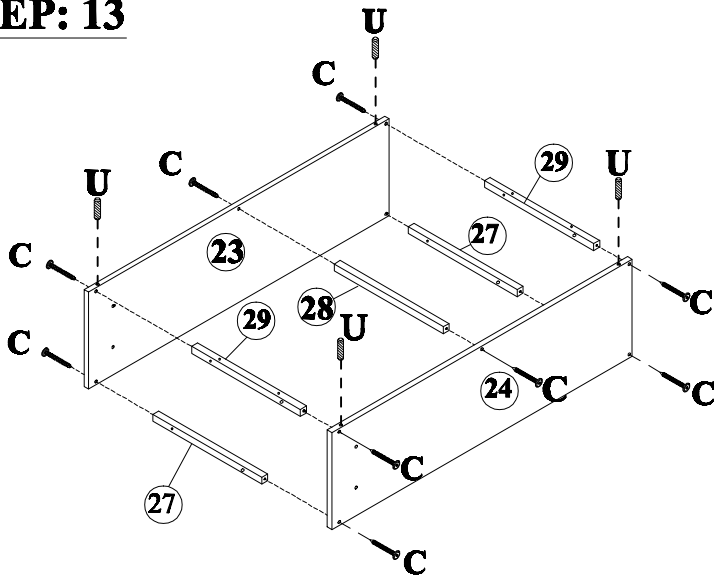

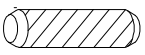
C	U
	
10 PCS	4 PCS

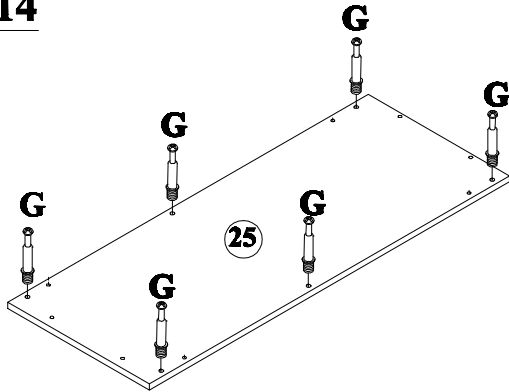

STEP: 14

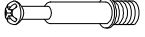

G

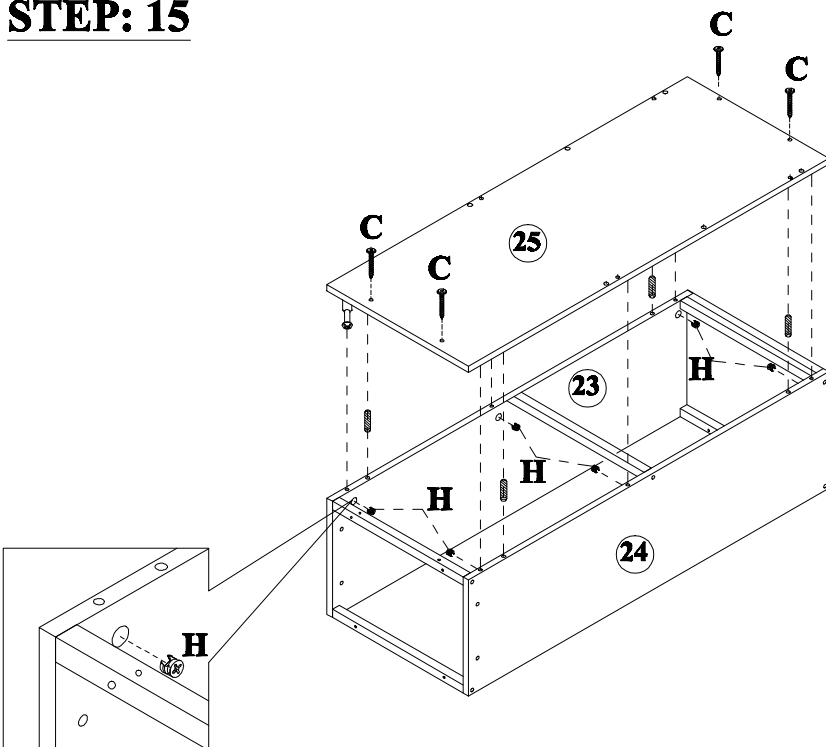
6 PCS



STEP: 15

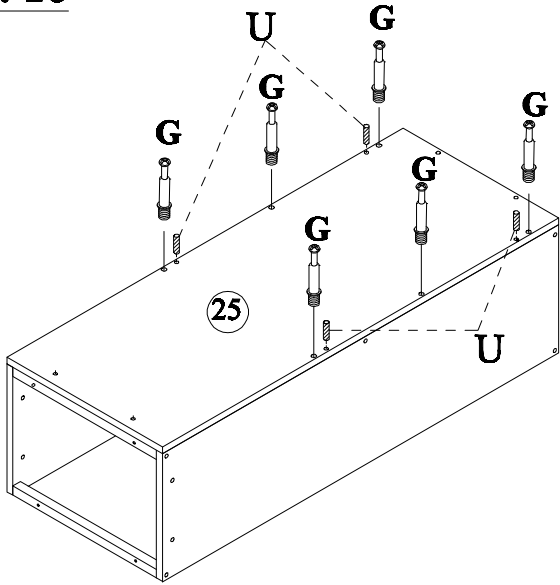

C	H
	
4 PCS	6 PCS

STEP: 16



G		U	
6 PCS		4 PCS	

STEP: 17

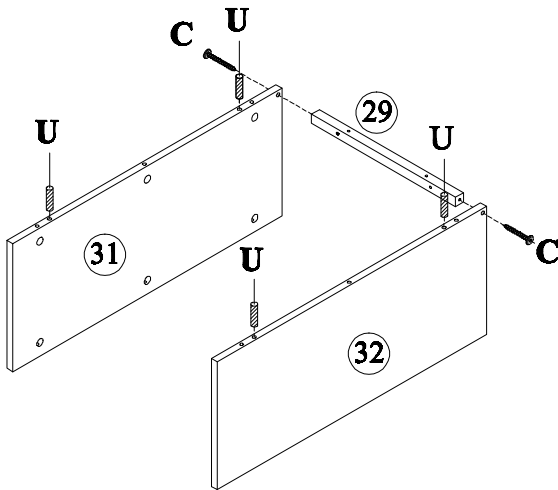

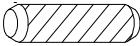

C		U	
2 PCS		4 PCS	

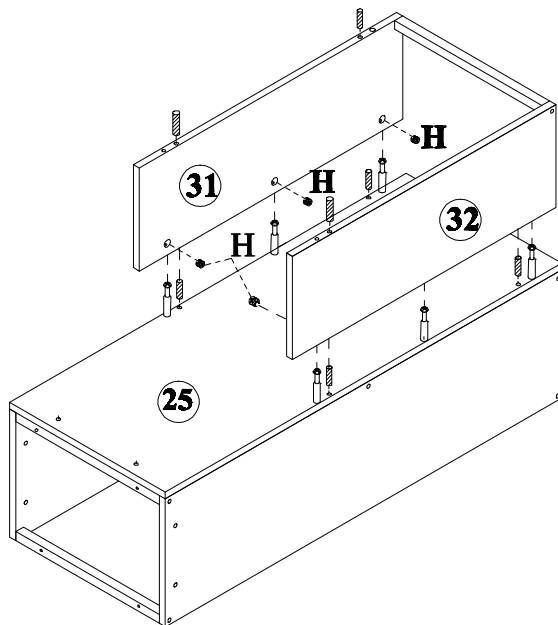
STEP: 18



H	
6 PCS	

STEP: 19

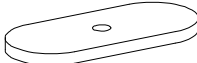
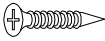
C		H		Q		R	
2 PCS		6 PCS		1 PC		5 PCS	

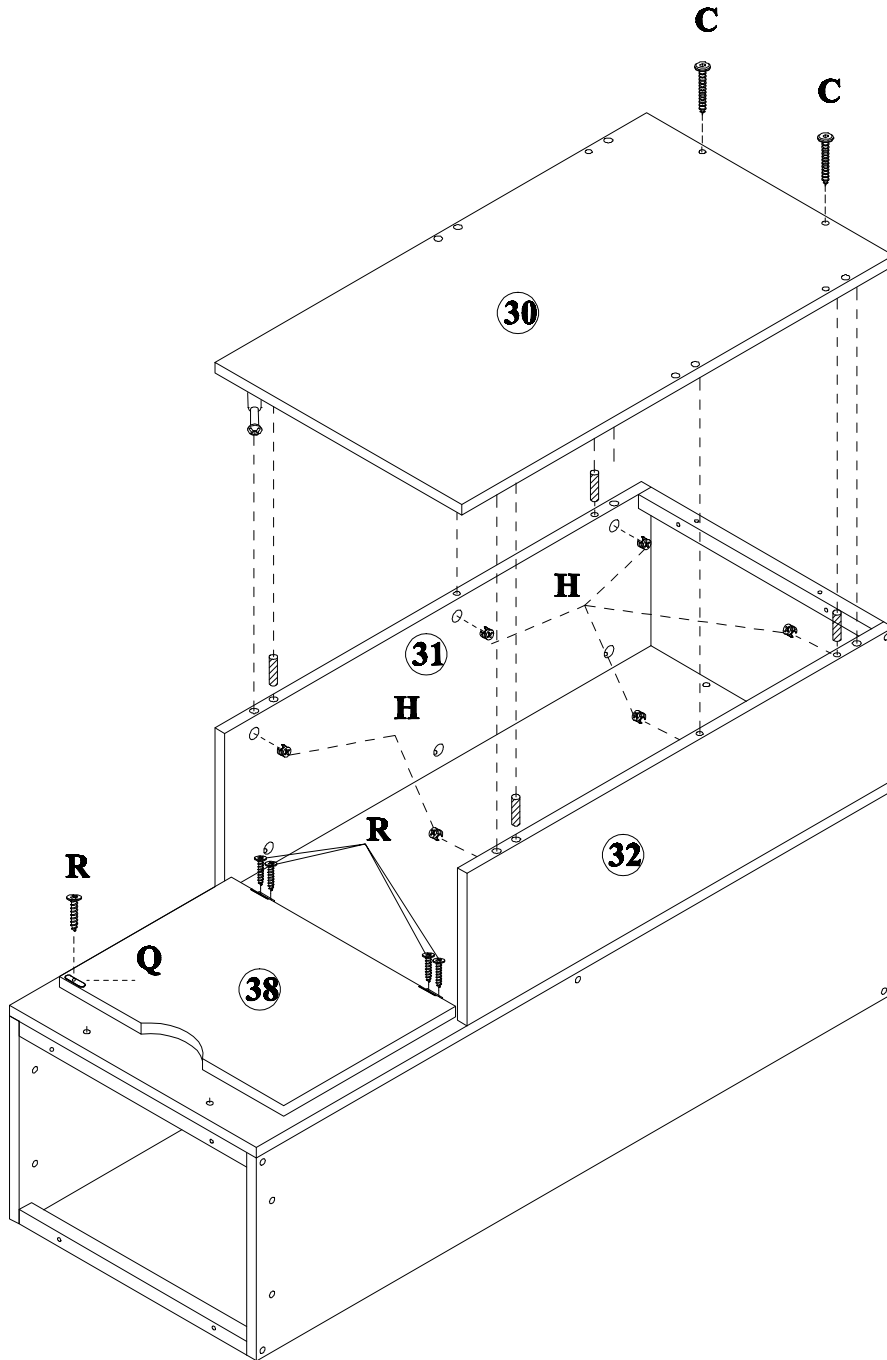

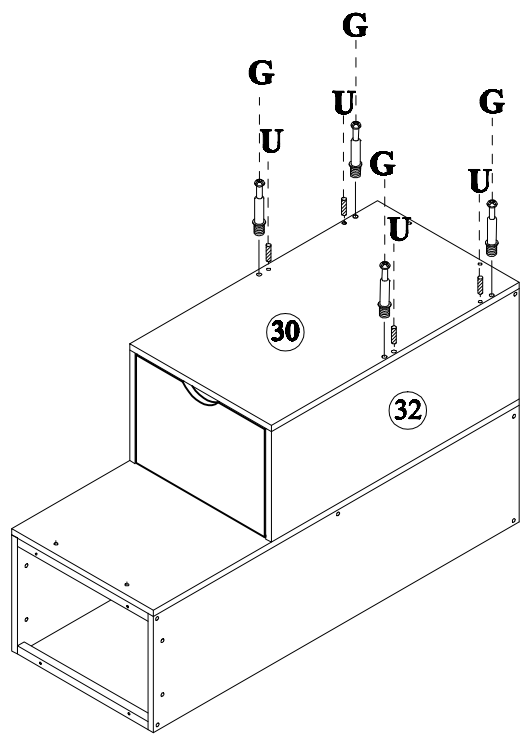

STEP: 20

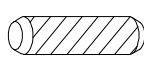
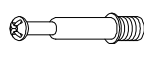

U		G	
4 PCS		4 PCS	

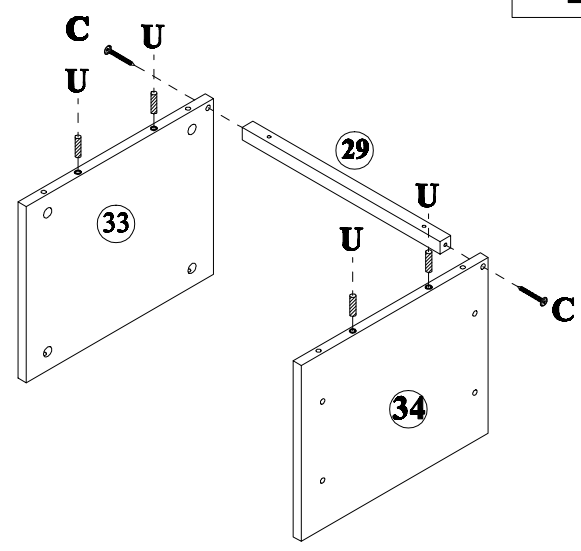
STEP: 21

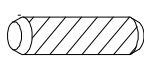

C		U	
2 PCS		4 PCS	

STEP: 22





H

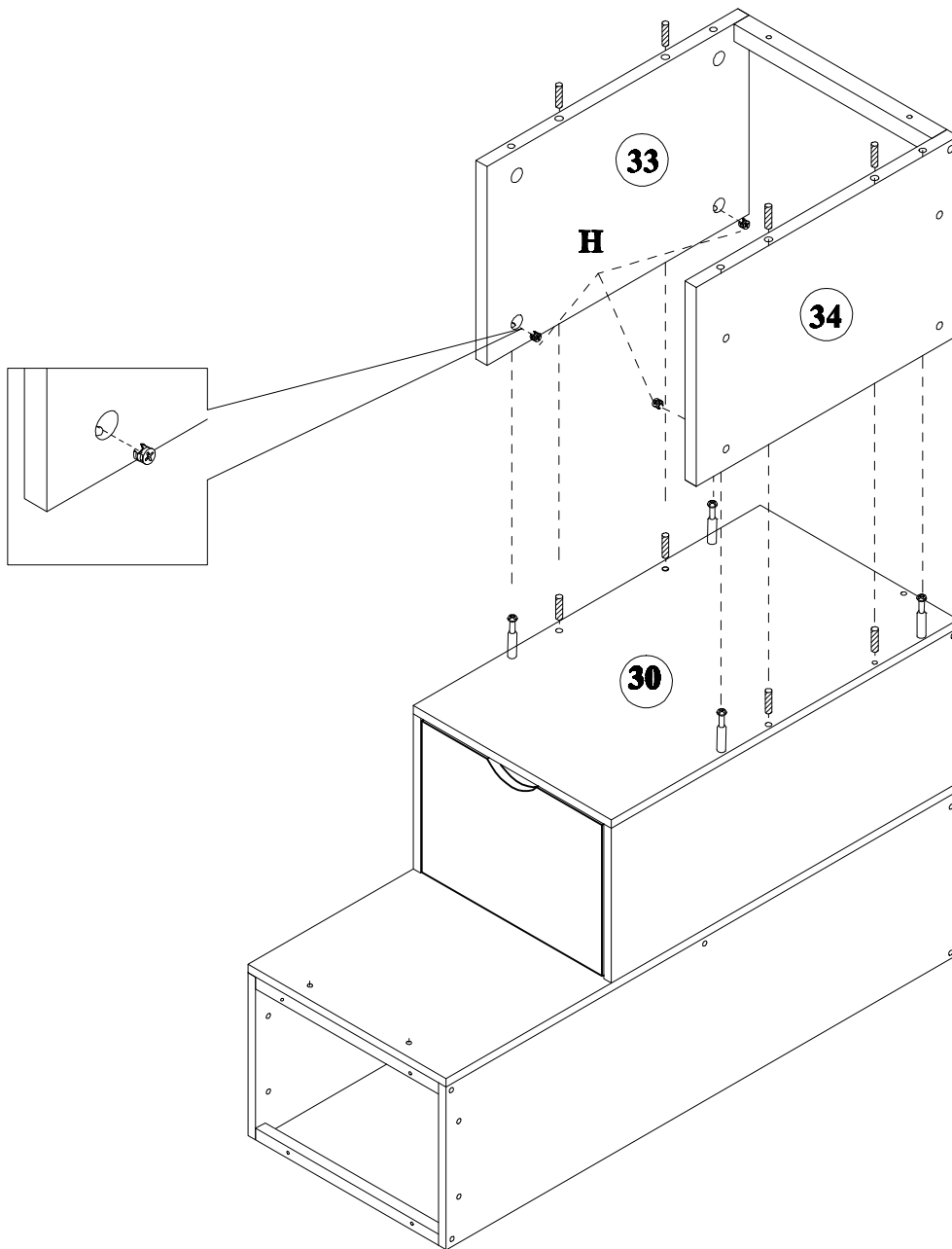

4 PCS

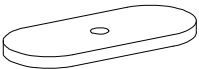

STEP: 23

C		H		Q		R	
2 PCS		4 PCS		1 PC		5 PCS	

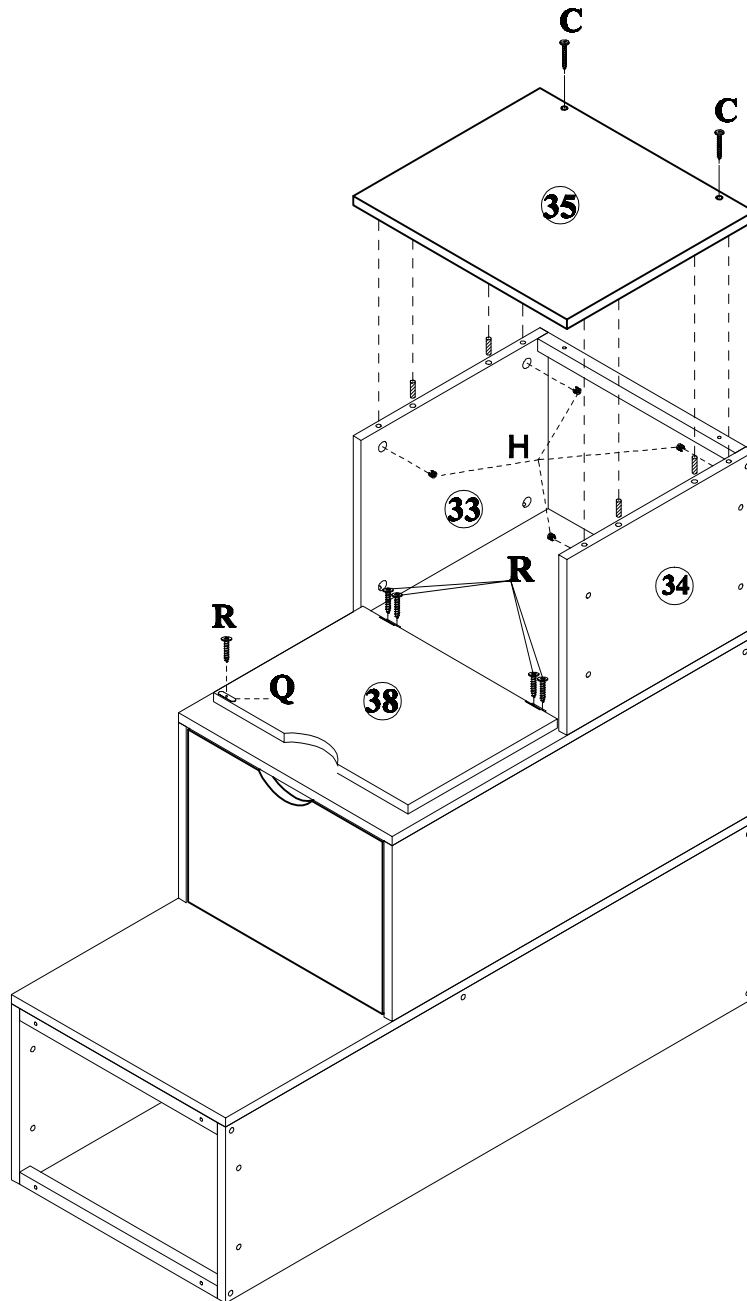

STEP: 24

C



6 PCS

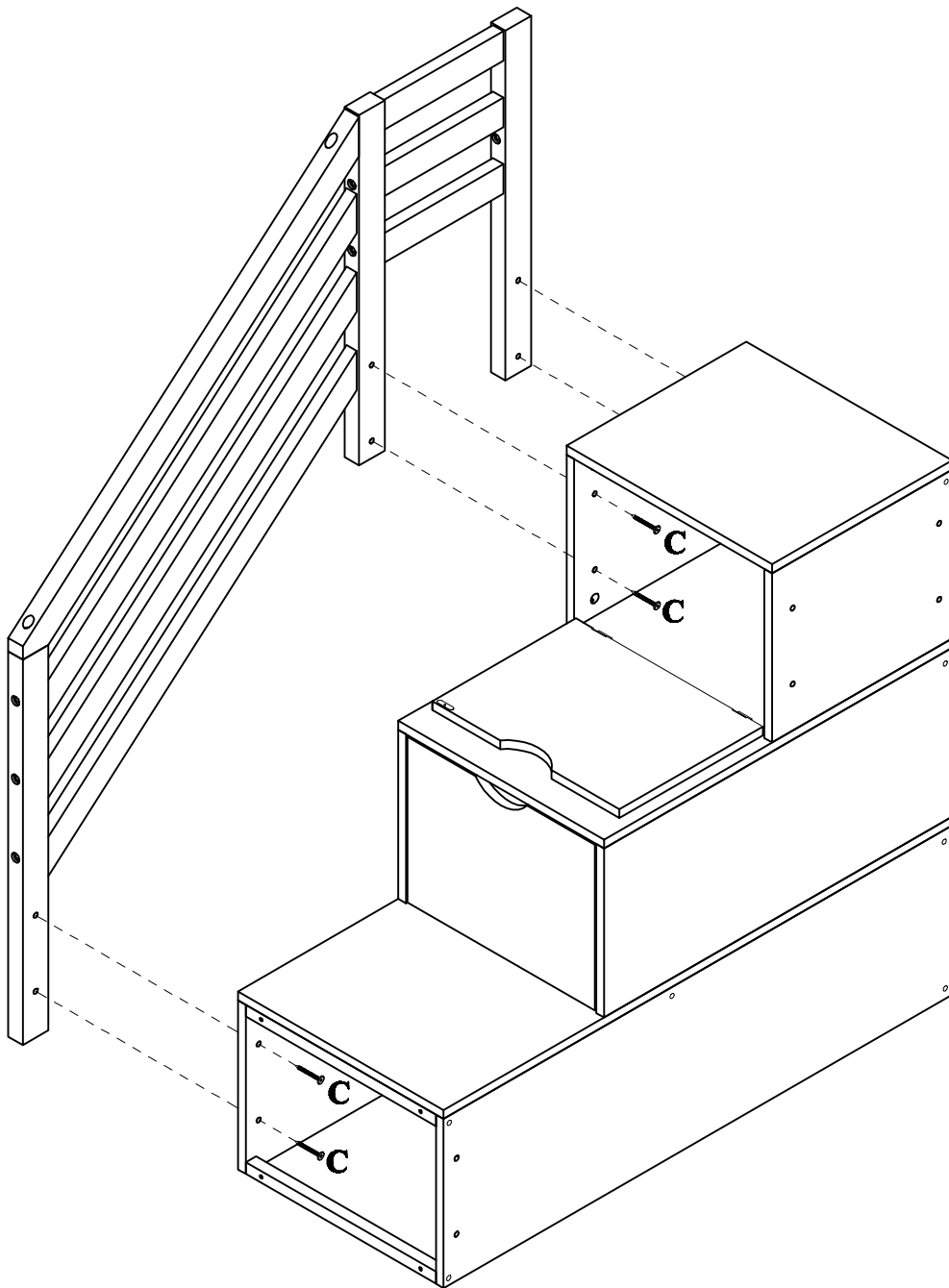

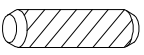

STEP: 25

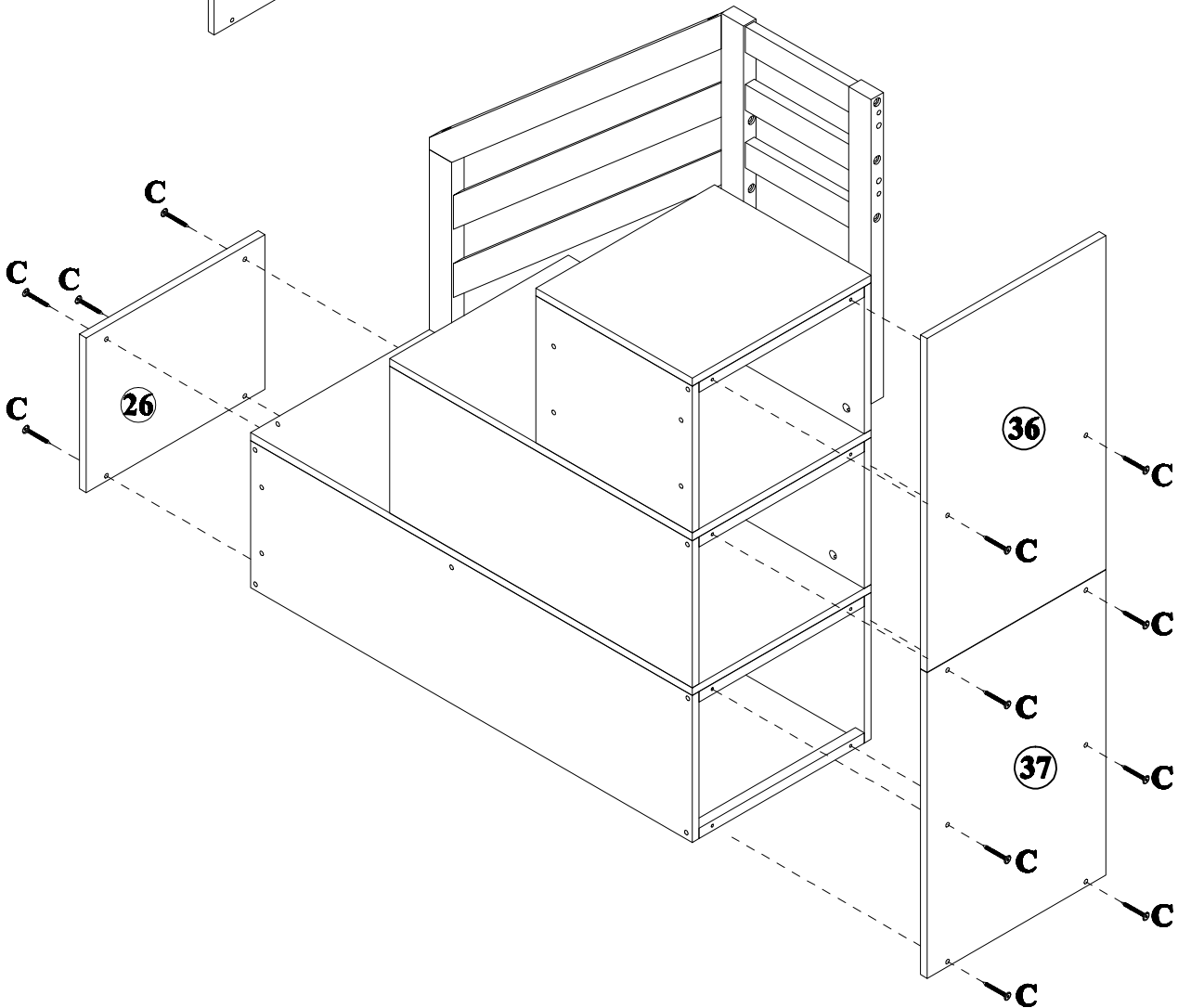
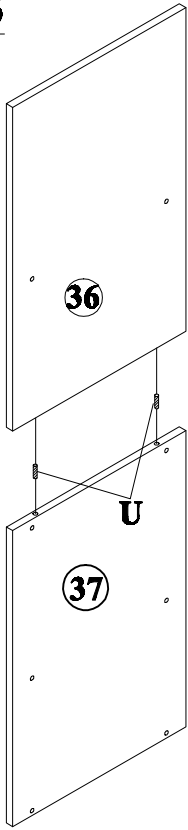
C	U
	
12 PCS	2 PCS

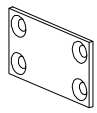

STEP: 26

M		N	
2 PCS		8 PCS	

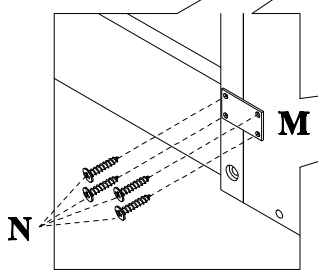
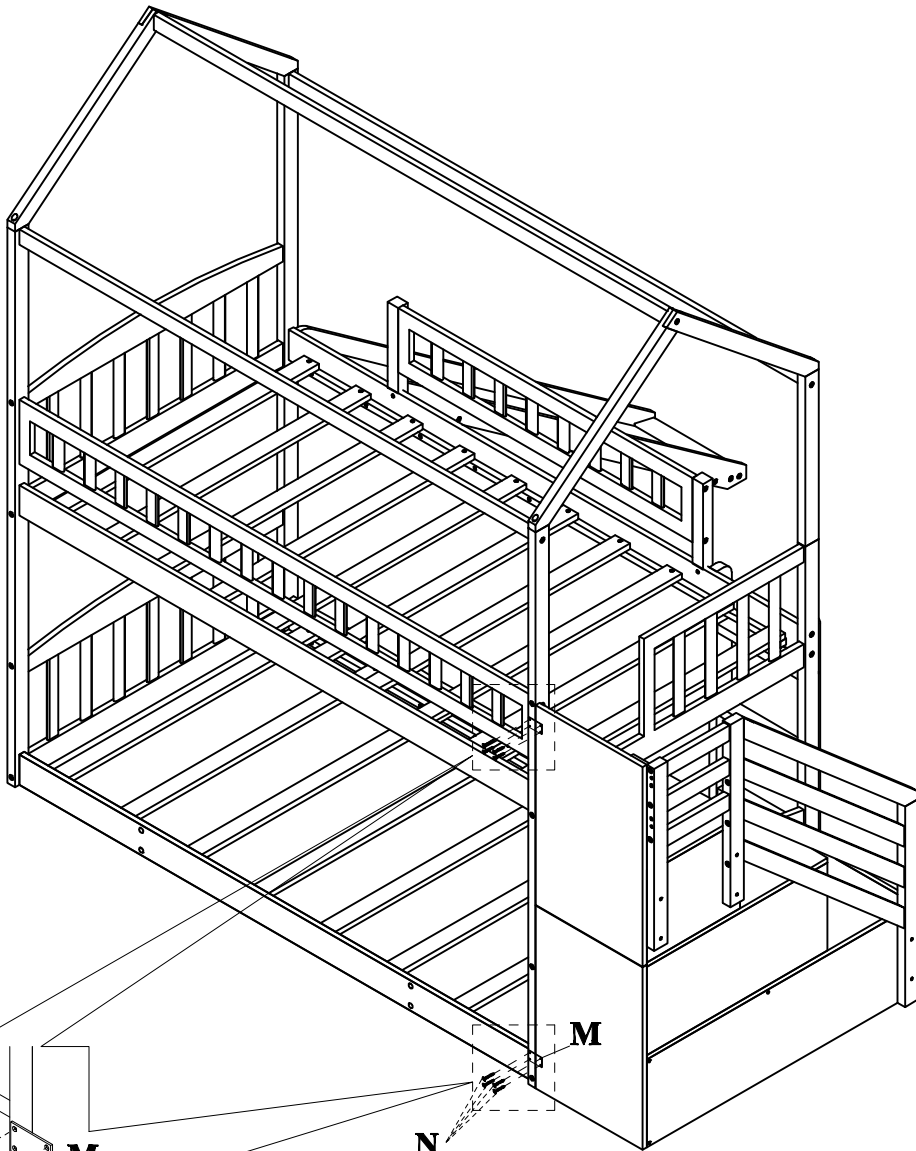

STEP: 27

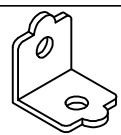
N	L
	
2 PCS	1 PC

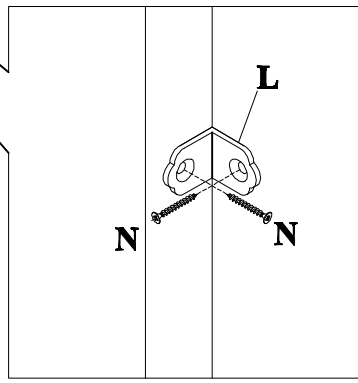
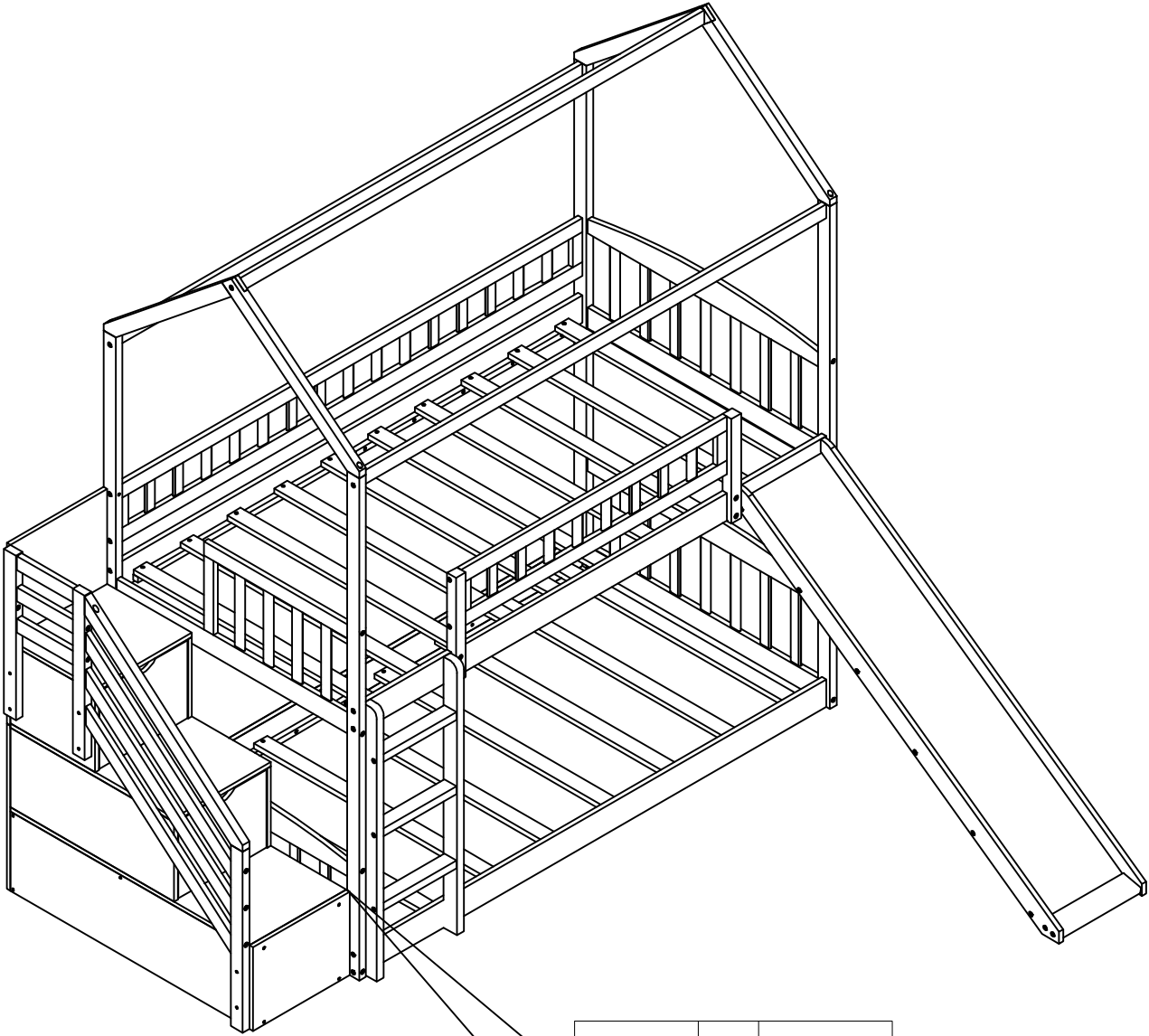

STEP:28

