

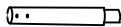

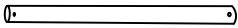









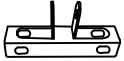
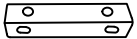





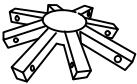

3.2x3.2

A		4pcs
B		4pcs
C		4pcs
D		4pcs
E		4pcs
F		4pcs
G		4pcs
H		4pcs
I		4pcs
J		4pcs
K		4pcs
L		16pcs
M		1pc
N		32pcs
O	 M6*60	16pcs
P	 M6*30	32pcs
Q	 M6*15	28pcs
R		1pc
S		1pc
T		1pc
U		1pc
X		48
Z		1/1
Z1		8pcs
Z2		4pcs

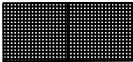
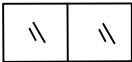

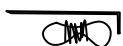
1

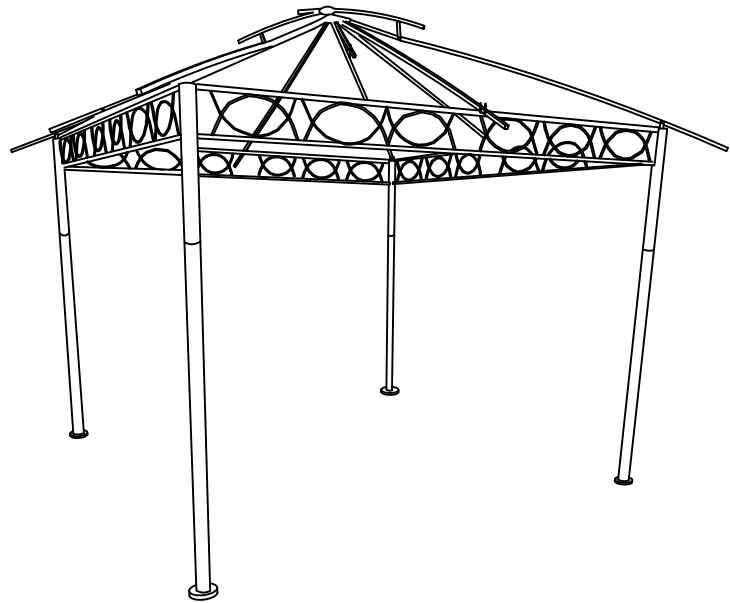
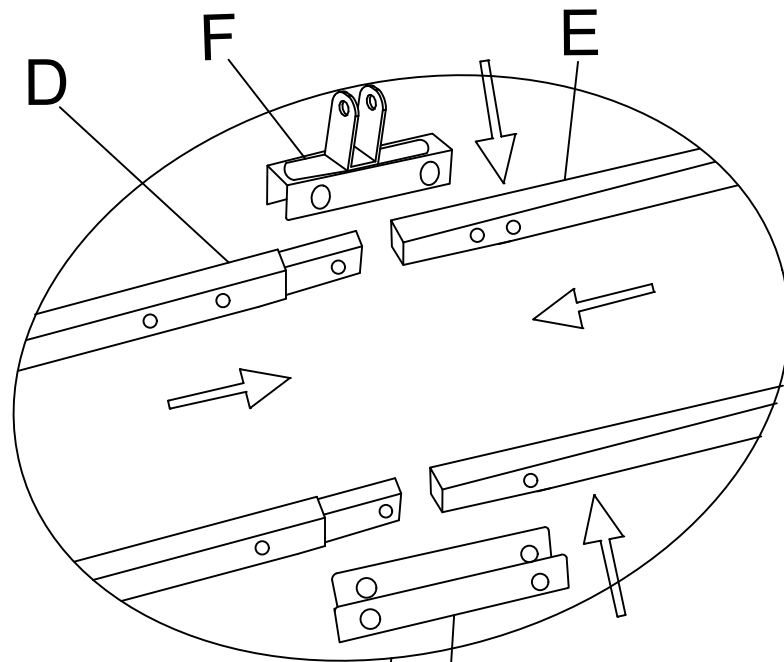

1

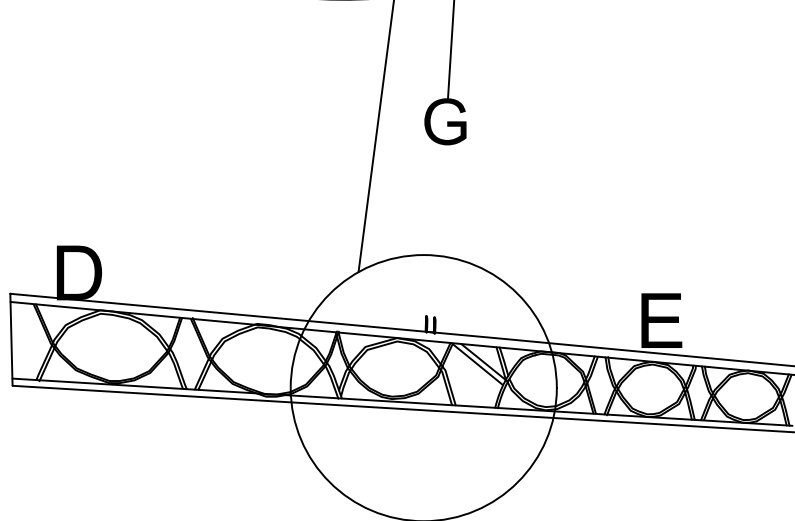

G

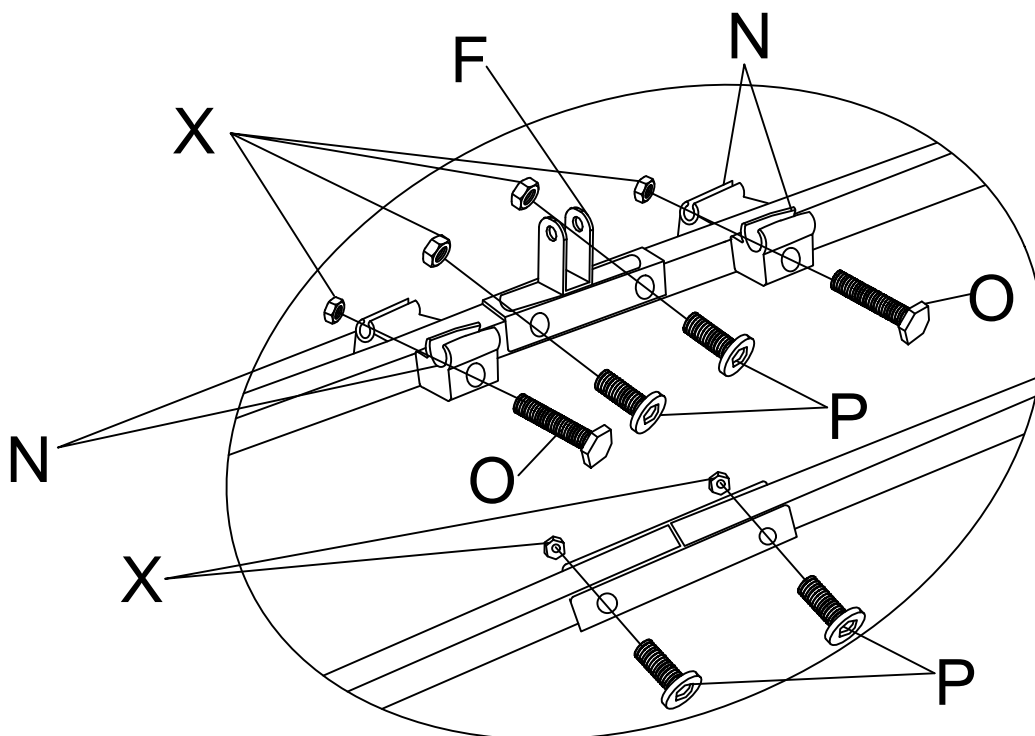

2

2

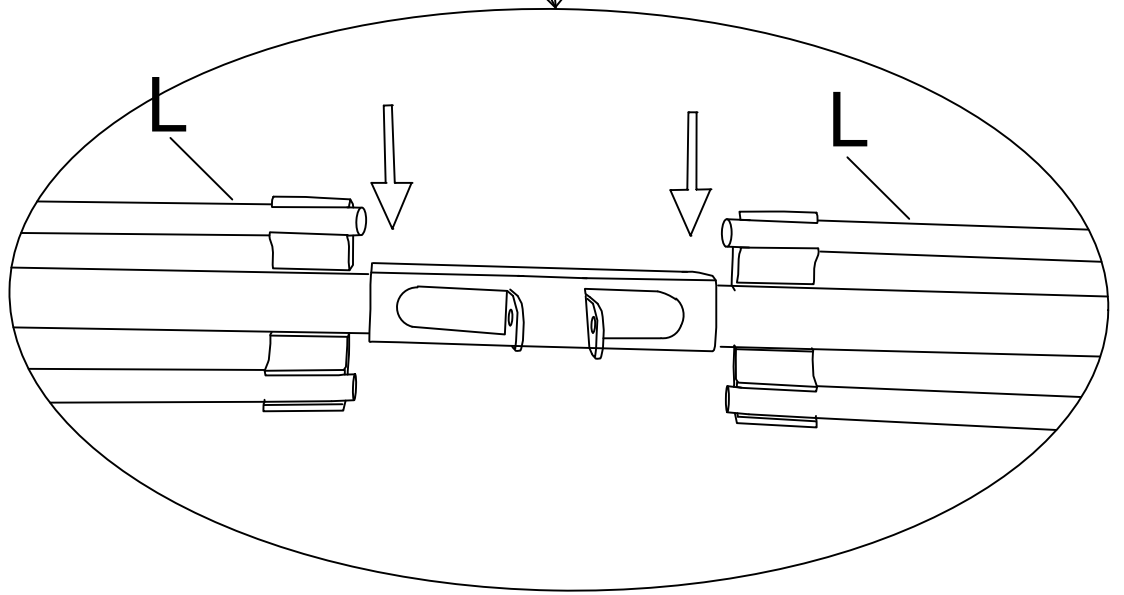
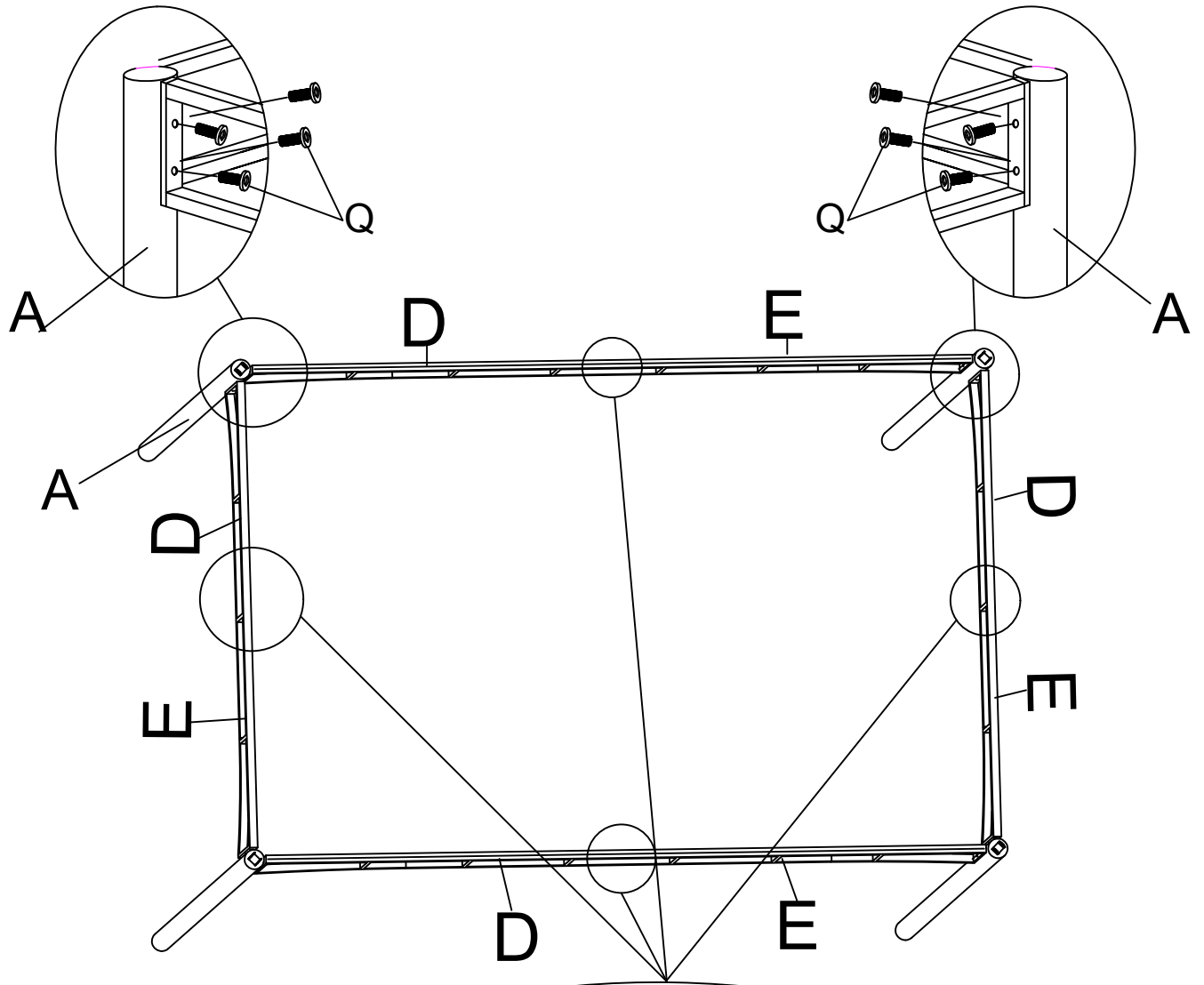

3

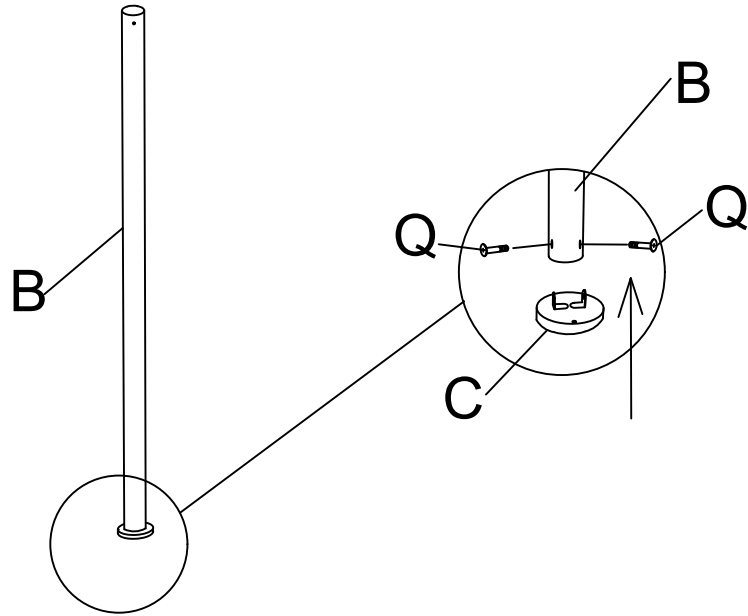

4

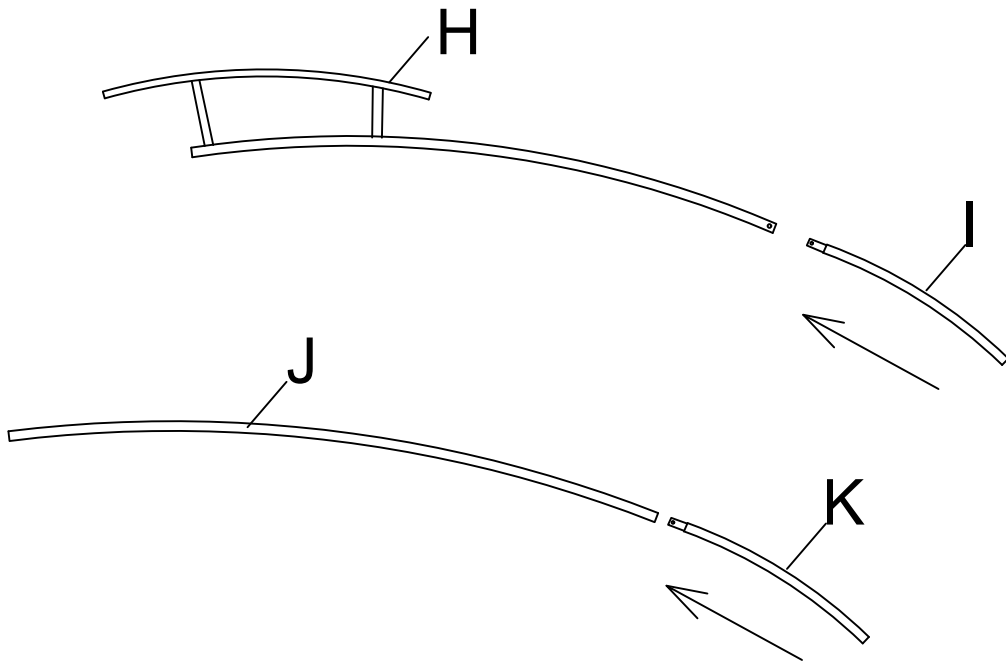

5

H insert into the longer tube

J insert into the shorter tube

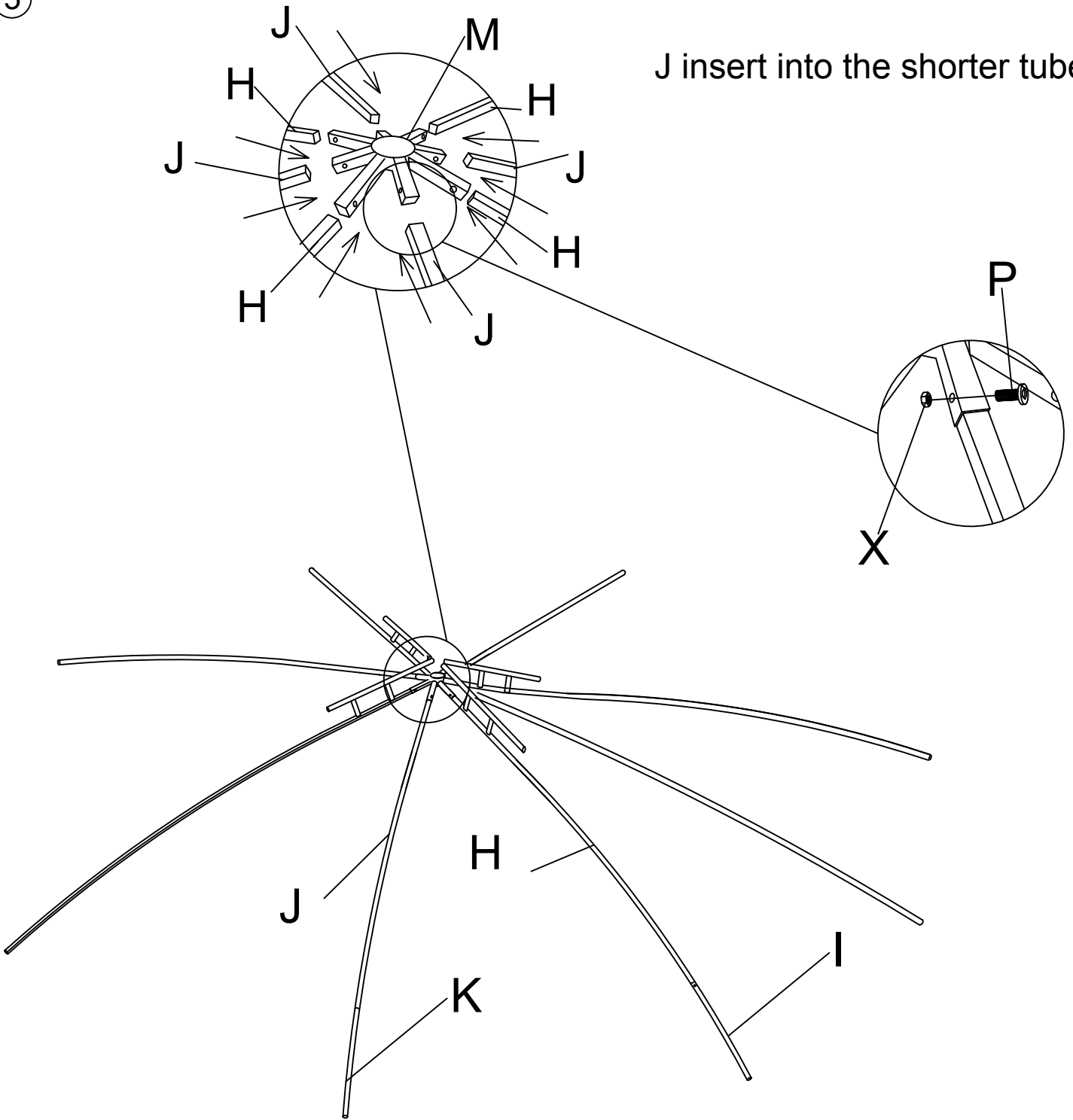

6

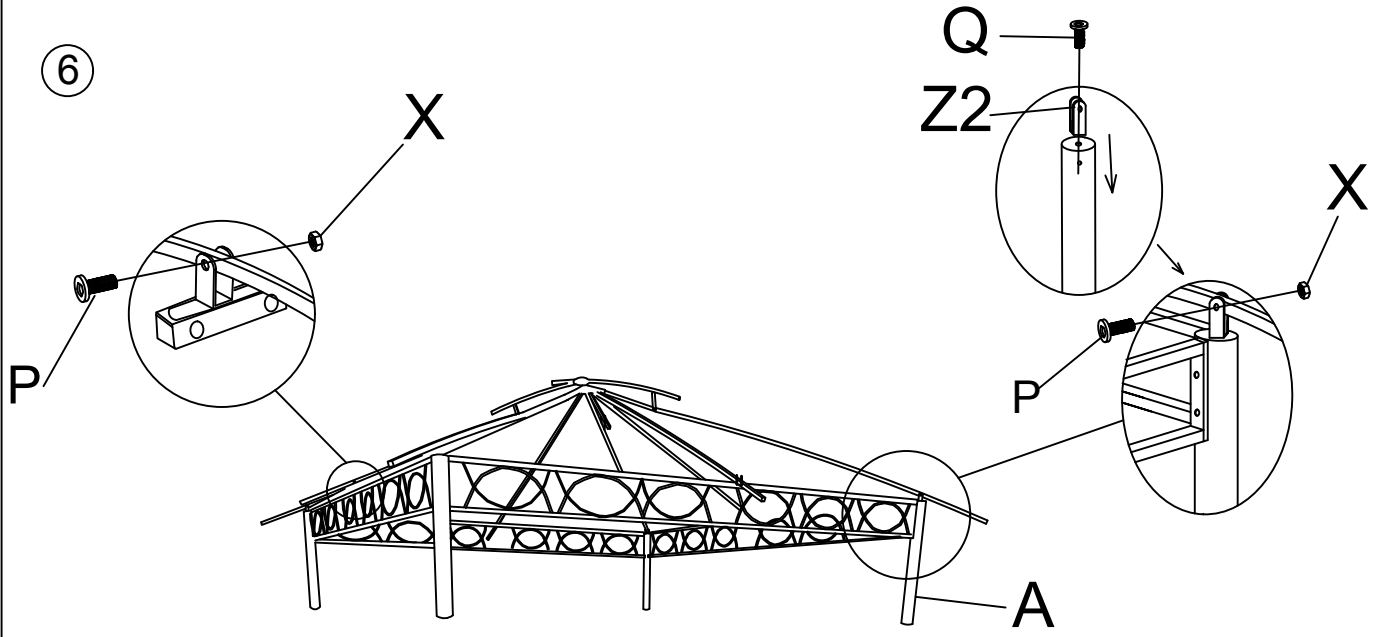

7

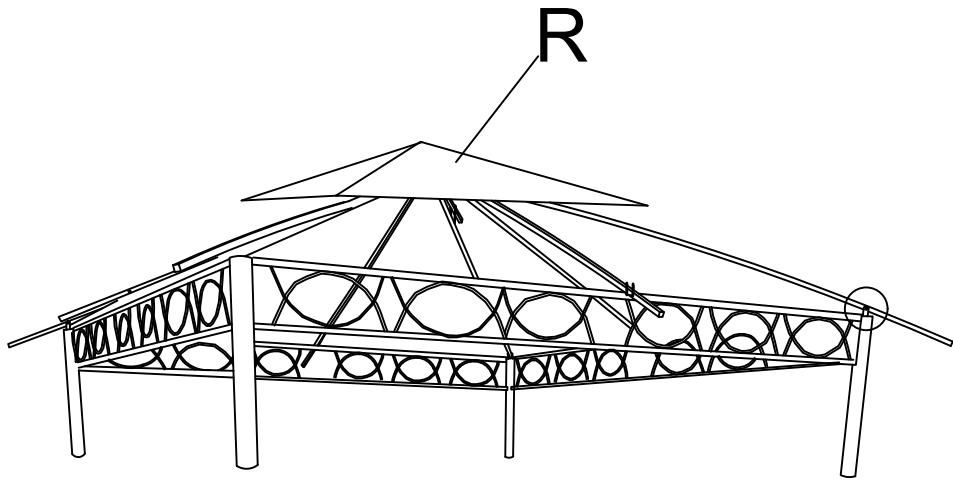

8

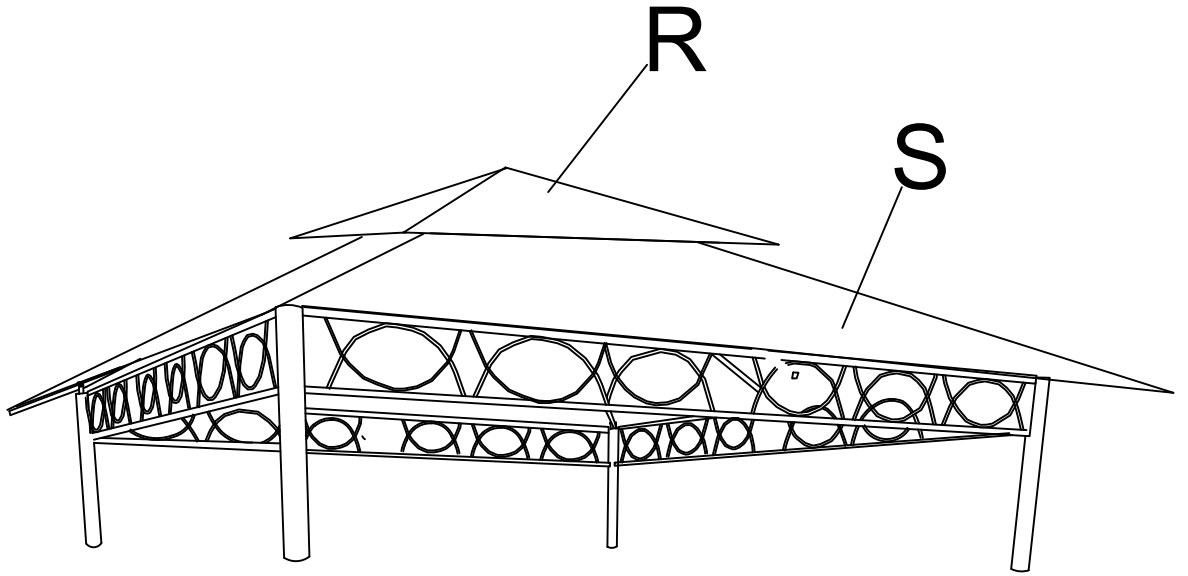

9

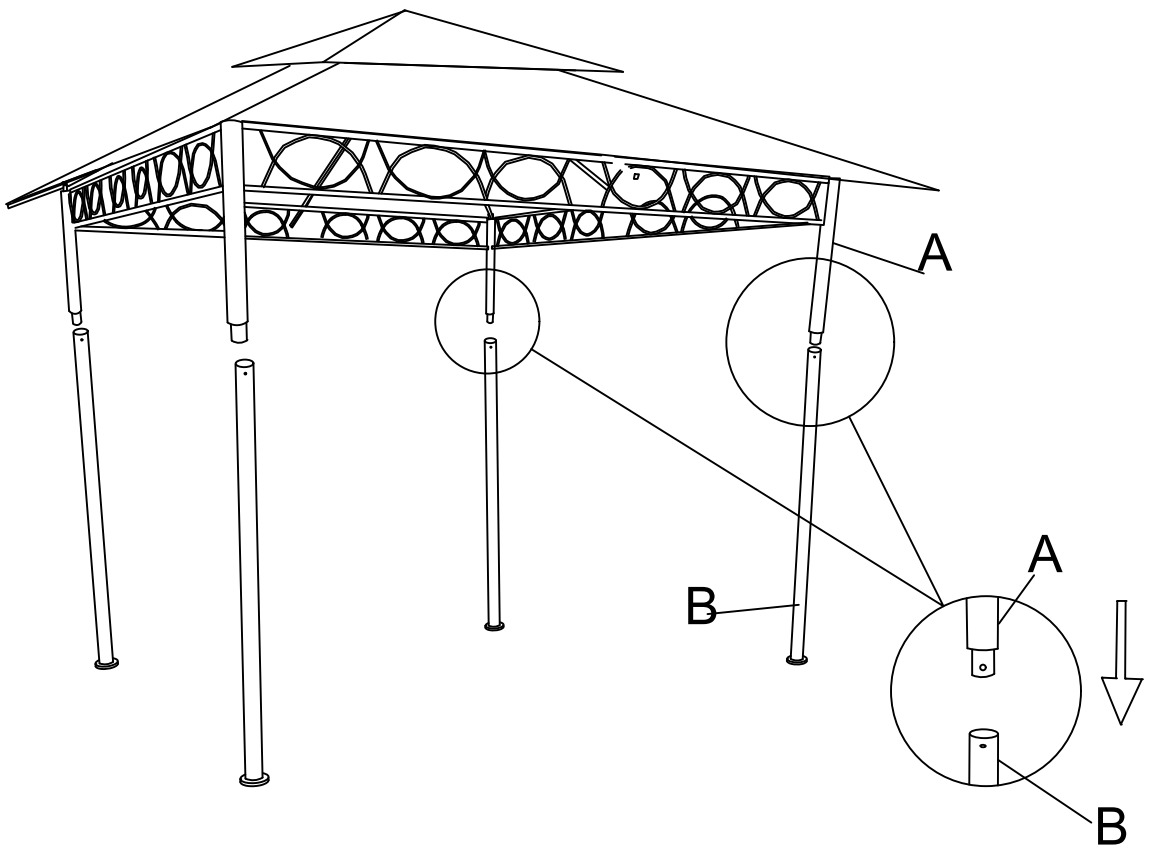

10

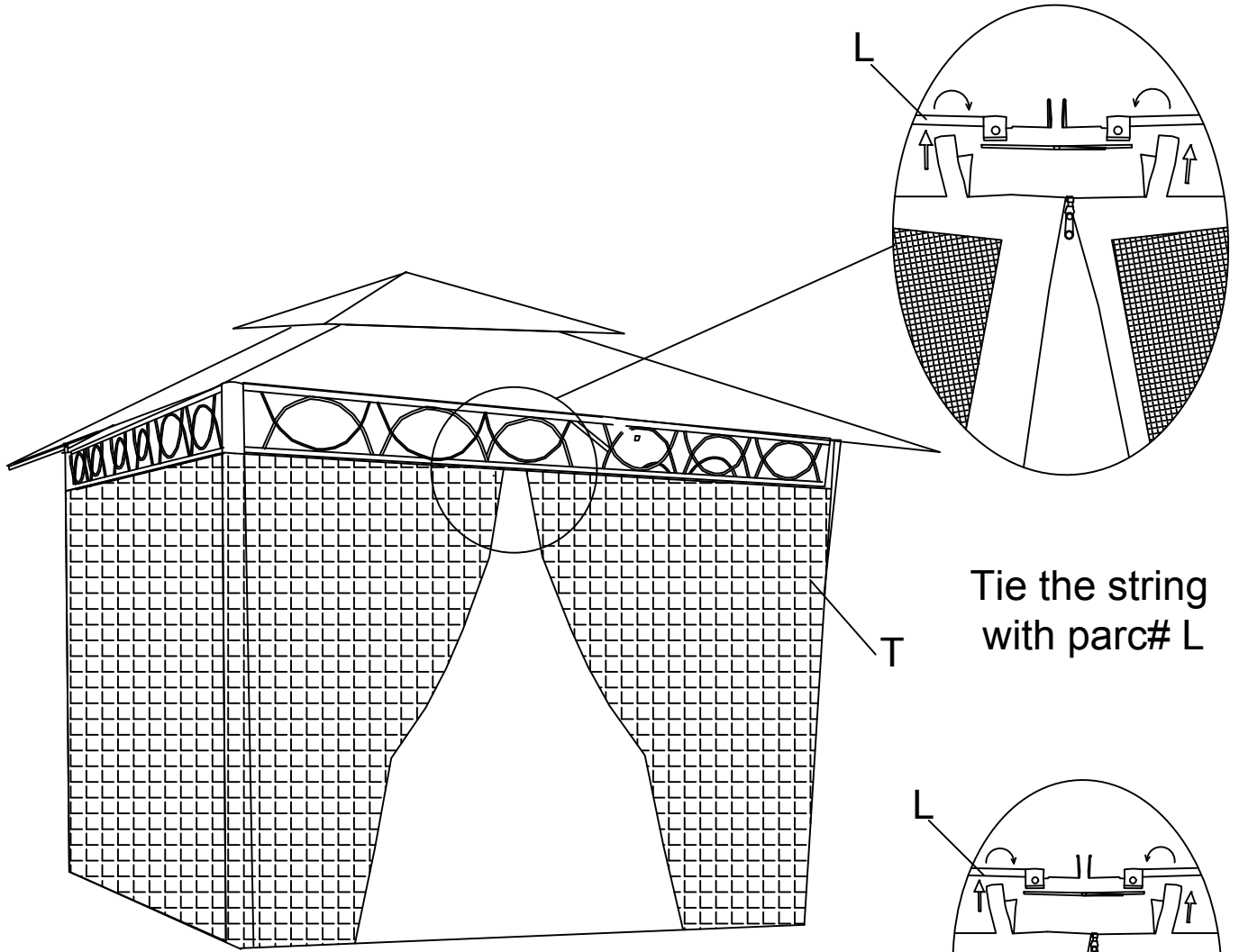

Tie the string with parc# L

11

