

ASSEMBLY INSTRUCTION

9PCS RATTAN DINING SET

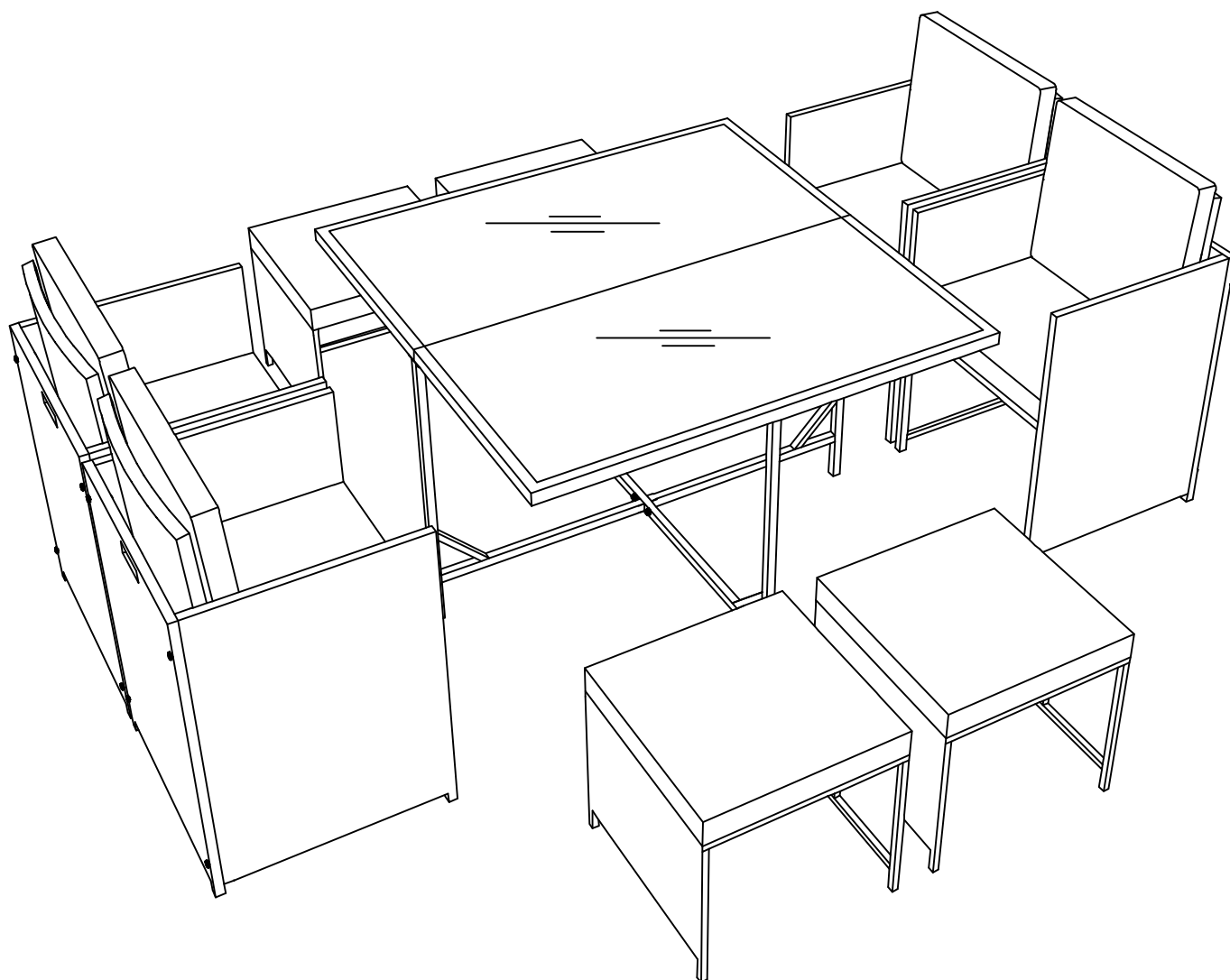

WF191845; WF191846



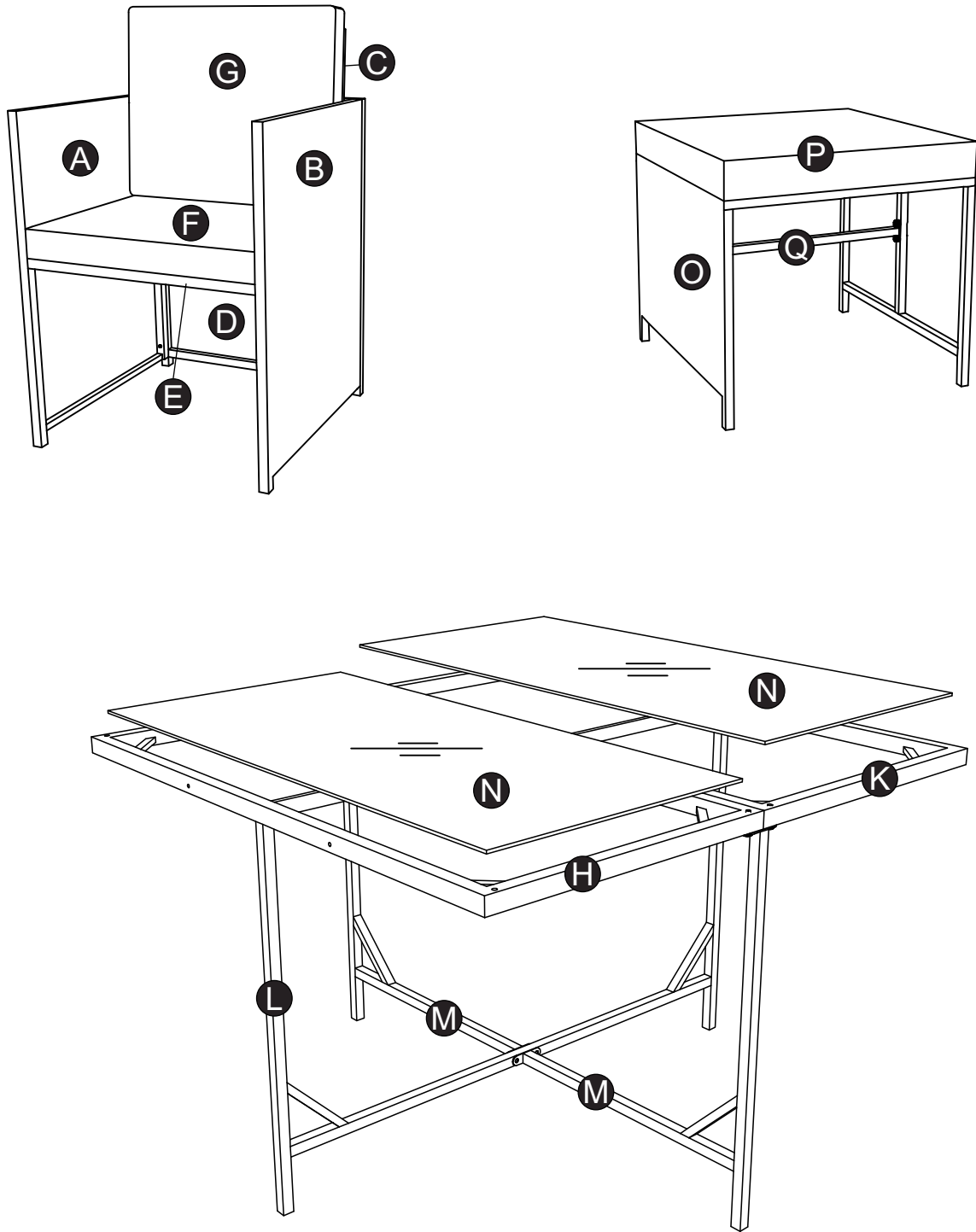





Exploded View

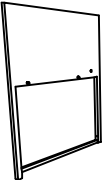
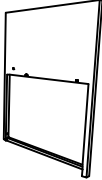

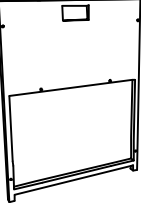
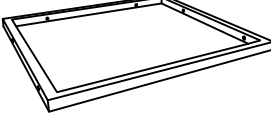
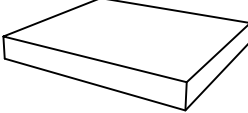
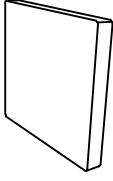
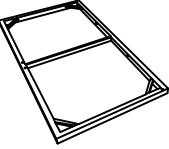
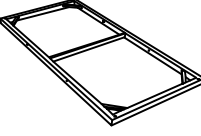
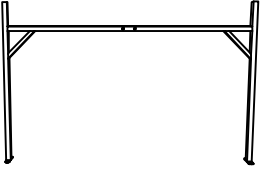
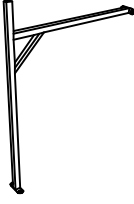
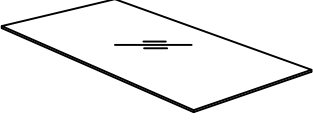
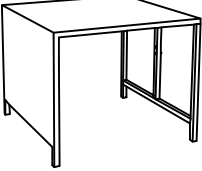
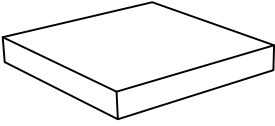
Notice:

1. 50% Tighten before fixing all screws, Allen wrench is recommended instead of an electric drill.
2. Place the item on a flat ground to adjust and make sure it remains stable.
3. Tighten up all screws with tools gradually.
4. If the screws are not aligned with holes during assembly, please loosen all the other screws to 50% and continue the assembly process.
5. If the item is not stable, please loosen all the screws, adjust it on a flat ground and tighten up all screws again.
6. Note : If one or some screws are fully tightened during assembly, chances are the others will not be aligned with holes. In addition, all the holes are designed to be relatively larger to provide more space for the adjustment of the screws.

Part List & Hardware

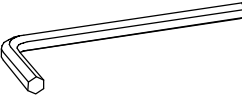
<p>A</p>  <p>(4pcs)</p>	<p>B</p>  <p>(4pcs)</p>	<p>C</p>  <p>(4pcs)</p>
<p>D</p>  <p>(4pcs)</p>	<p>E</p>  <p>(4pcs)</p>	<p>F</p>  <p>(4pcs)</p>
<p>G</p>  <p>(4pcs)</p>	<p>H</p>  <p>(1pc)</p>	<p>K</p>  <p>(1pc)</p>
<p>L</p>  <p>(1pc)</p>	<p>M</p>  <p>(2pcs)</p>	<p>N</p>  <p>(2pcs)</p>
<p>O</p>  <p>(4pcs)</p>	<p>P</p>  <p>(4pcs)</p>	<p>Q</p>  <p>(4pcs)</p>
<p>1</p>  <p>M6 x 40 mm</p> <p>(42pcs)</p>	<p>2</p>  <p>Ø6 x 14 mm</p> <p>(66pcs)</p>	<p>3</p>  <p>Ø8 x 16 x 3mm</p> <p>(8pcs)</p>
<p>4</p>  <p>M6 x 20 mm</p> <p>(24pcs)</p>	<p>5</p>  <p>M6 x 10mm</p> <p>(4pcs)</p>	<p>6</p>  <p>Allen key 4 x 60 mm</p> <p>(4pcs)</p>

CARTON CONTENT:

WF191845:

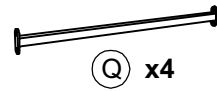
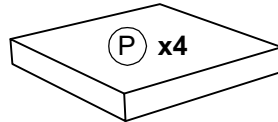
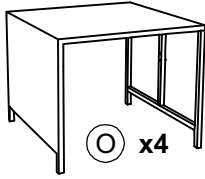
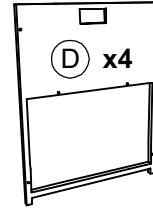
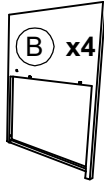
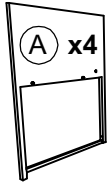

AI INCLUDED BOX-WF191846

Hardware

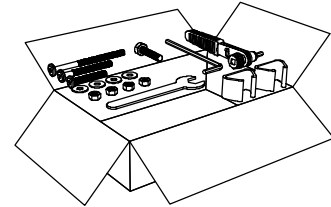

WF191846:

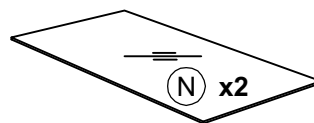
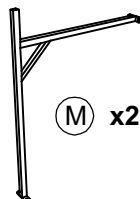
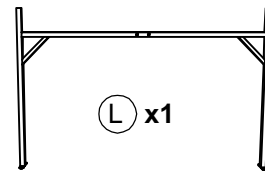
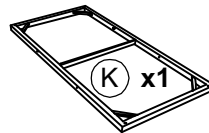
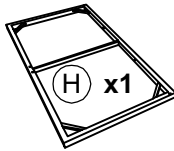
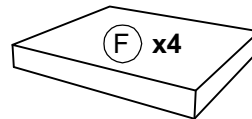
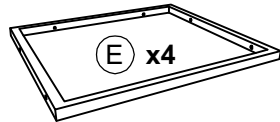
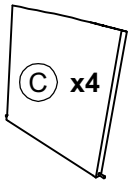

Step 1:

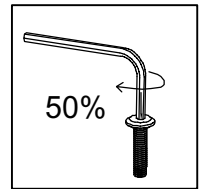
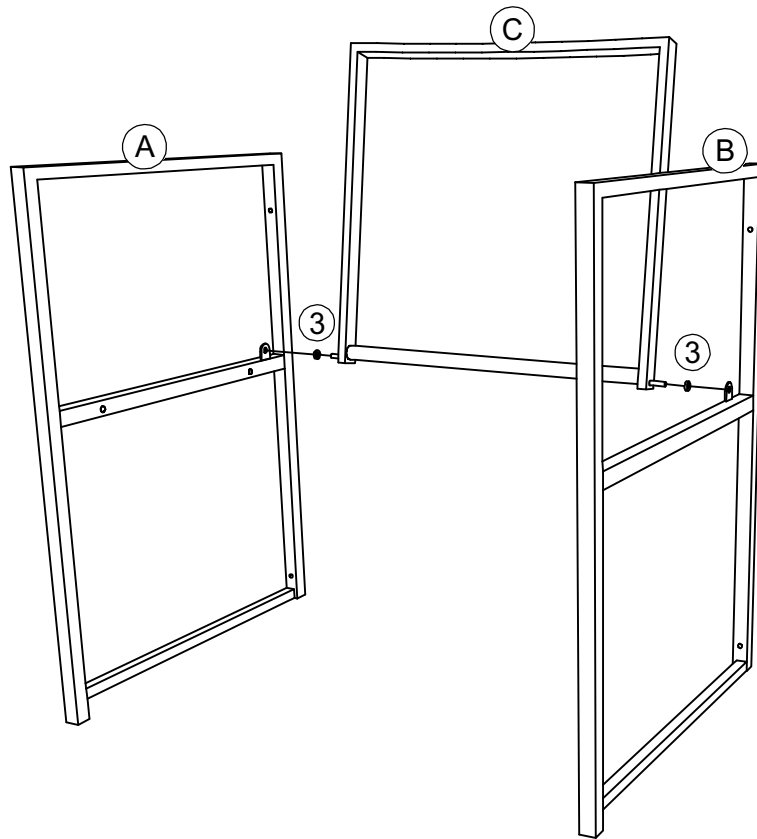

x4

③ *2

Step 2:

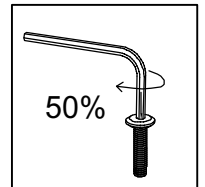
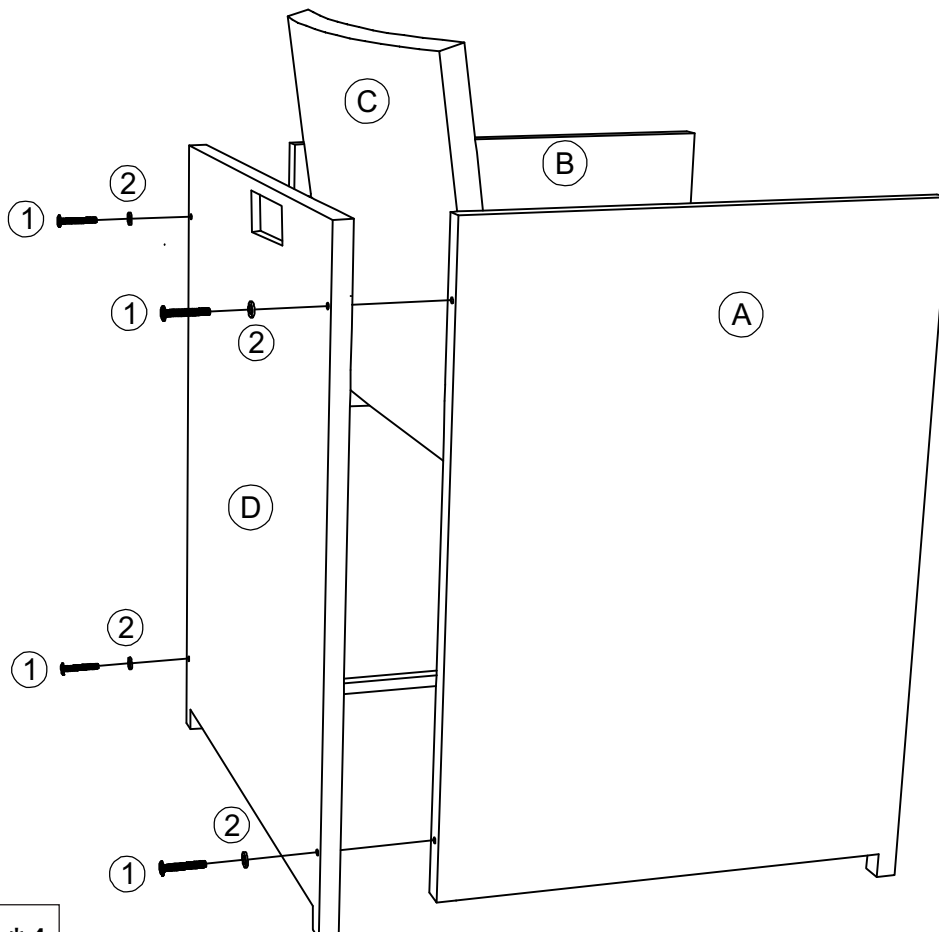

x4

① *4

② *4

Step 3:

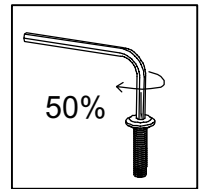
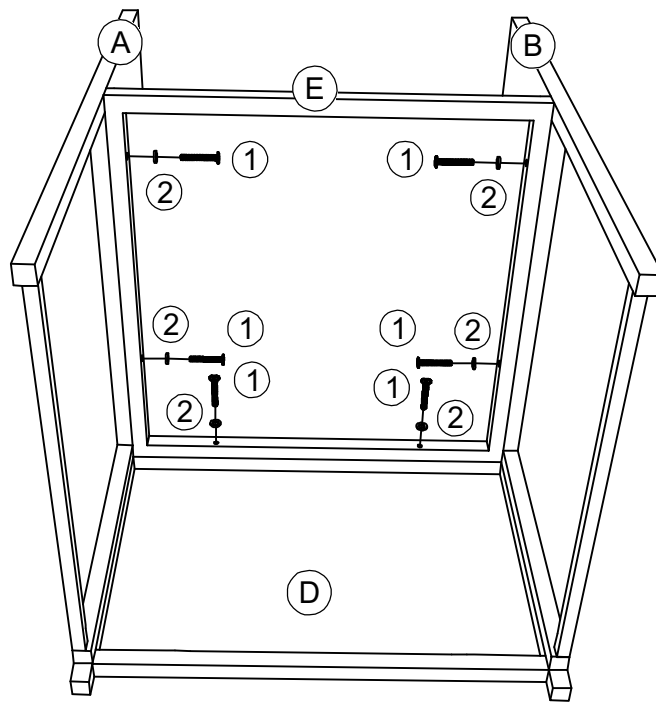

x4

① *6 ② *6

Step 4:

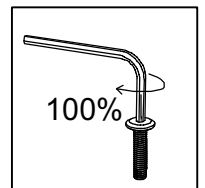
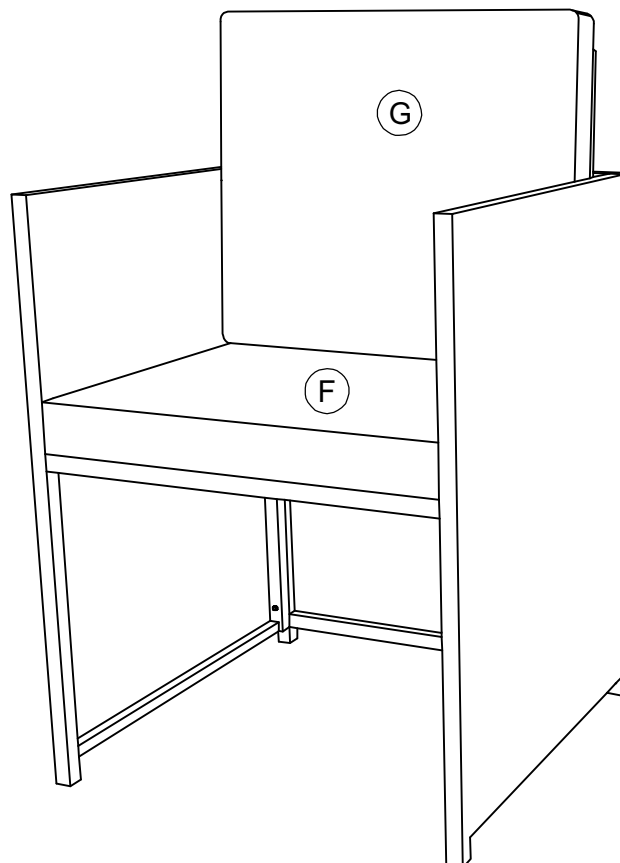

x4

Step 5:

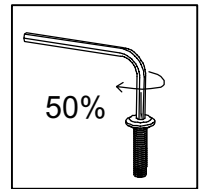
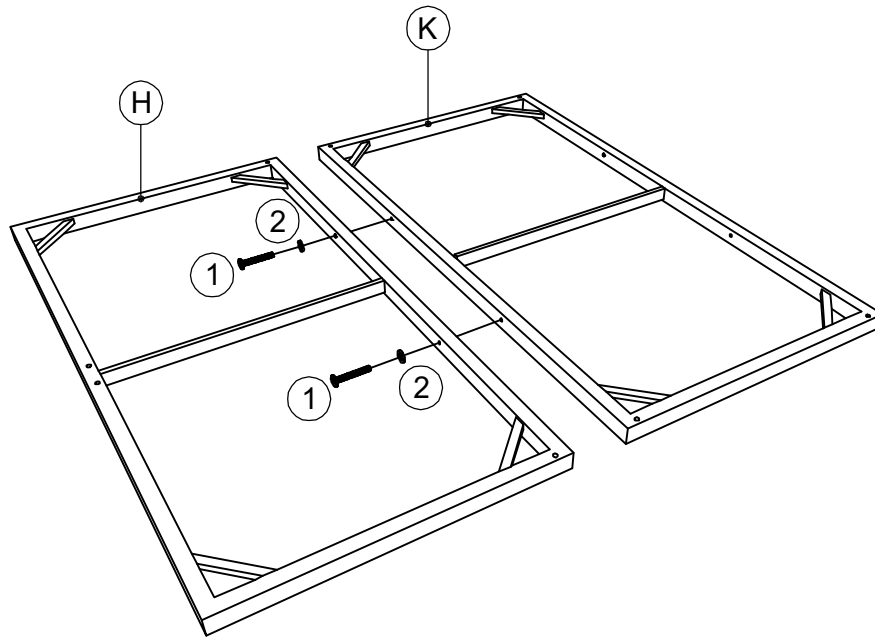

①*2 ②*2

Step 6:

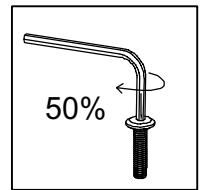
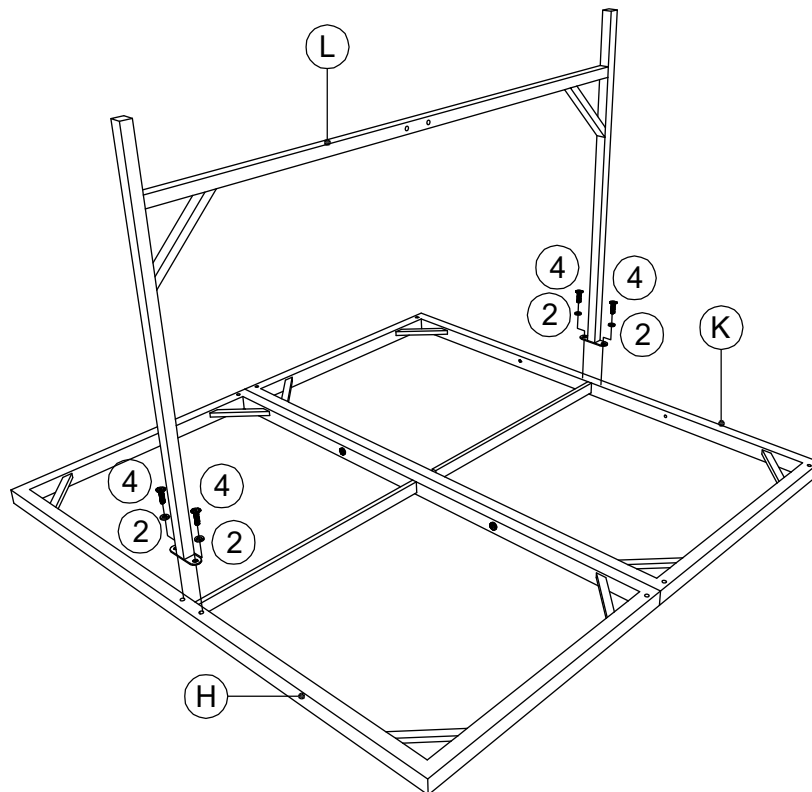

②*4 ④*4

Step 7:

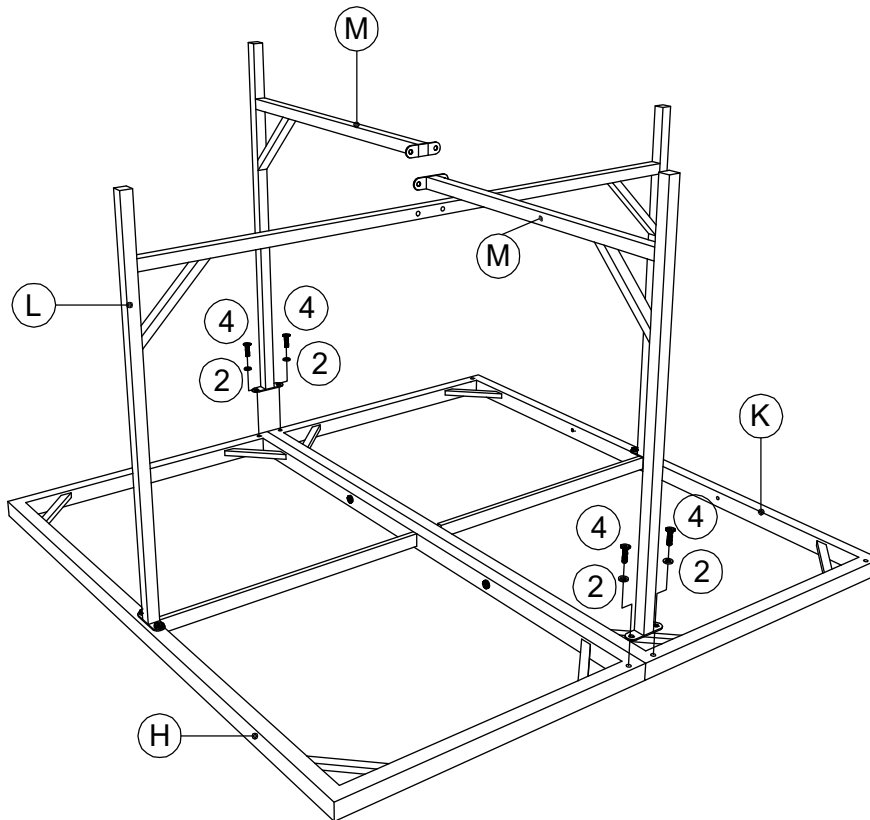
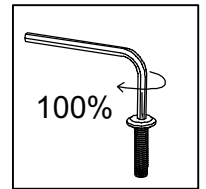

②*4 ④*4

Step 8:

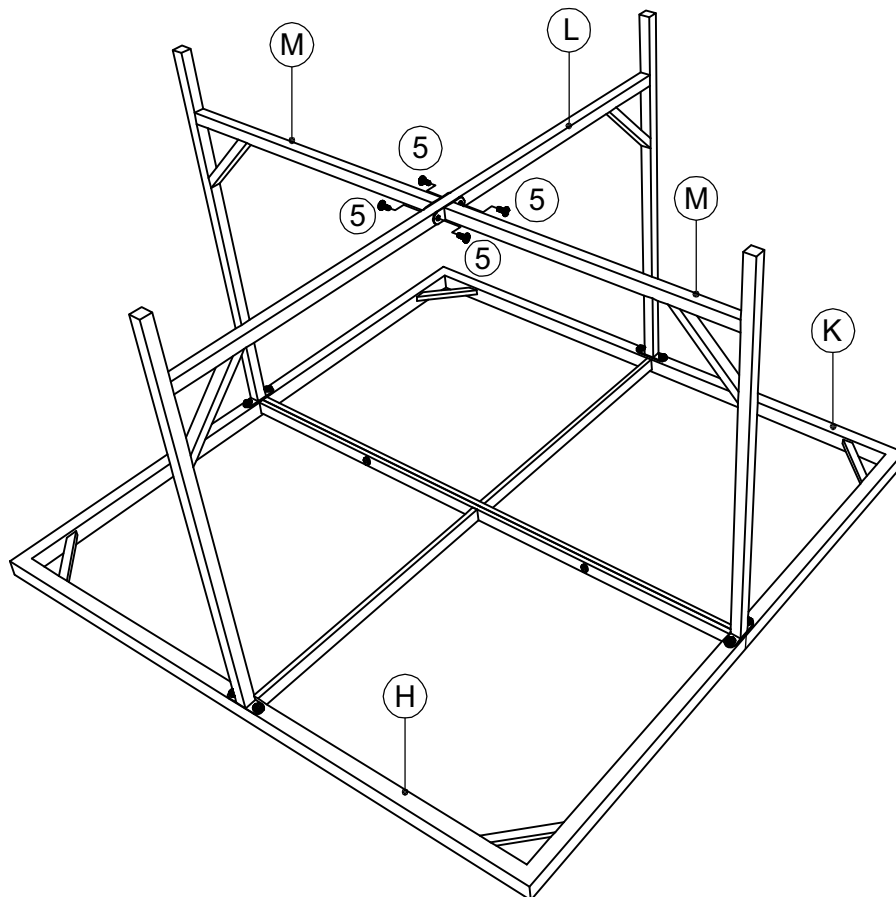

⑤*4

Step 9:

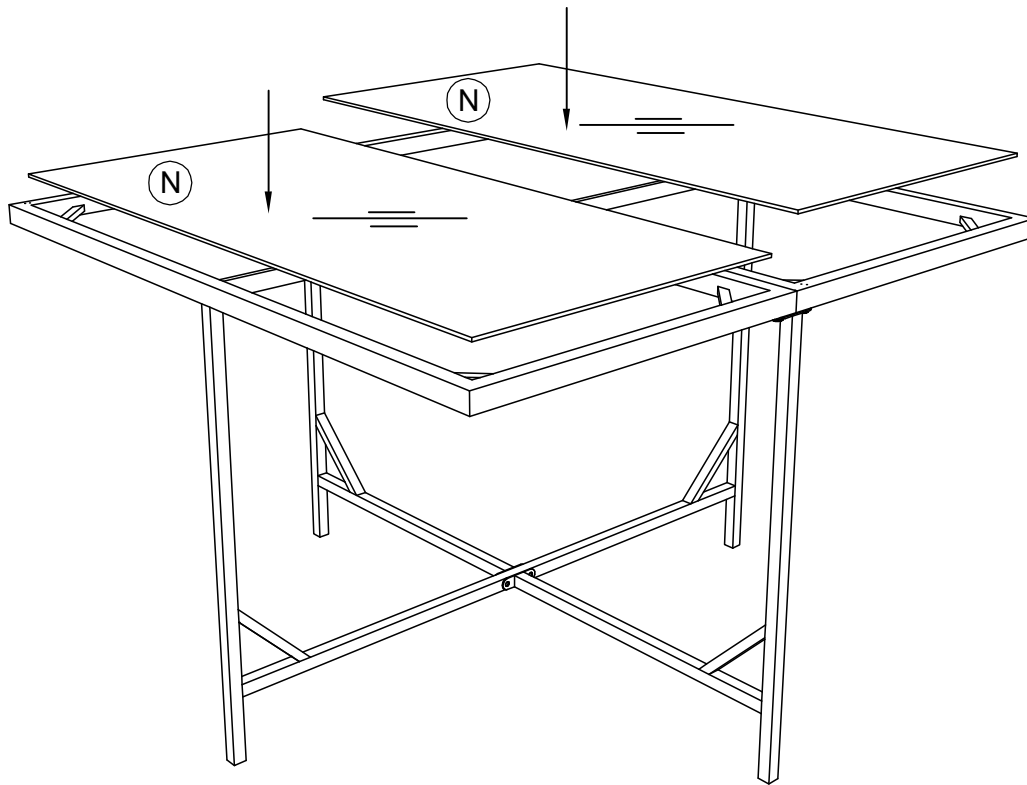

Step 10:

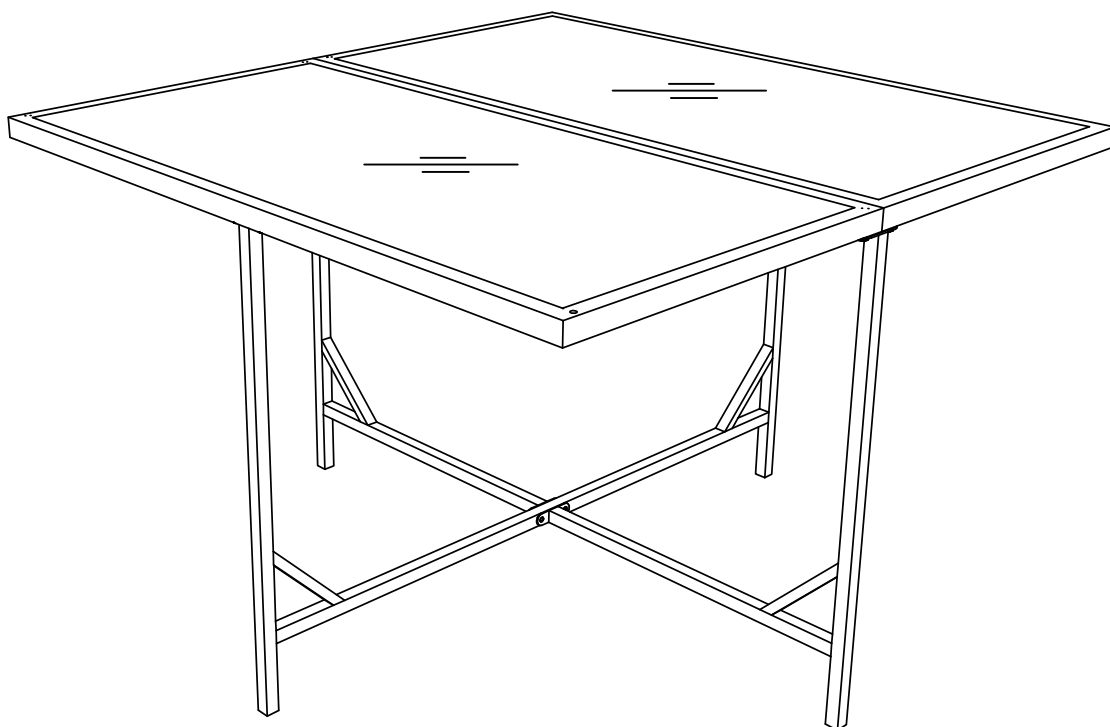

Step 11:

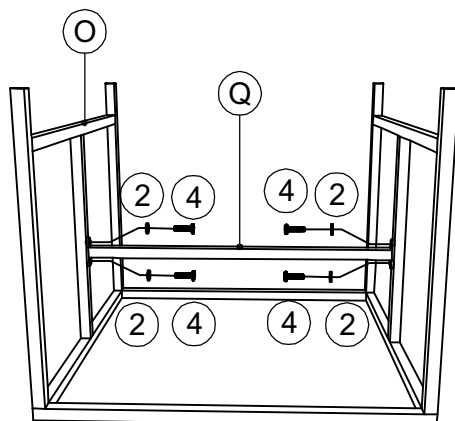
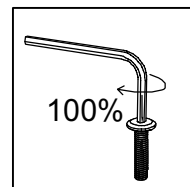

x4

② *4 ④ *4

Step 12:

