

# Low Profile Platform Bed ASSEMBLY INSTRUCTIONS

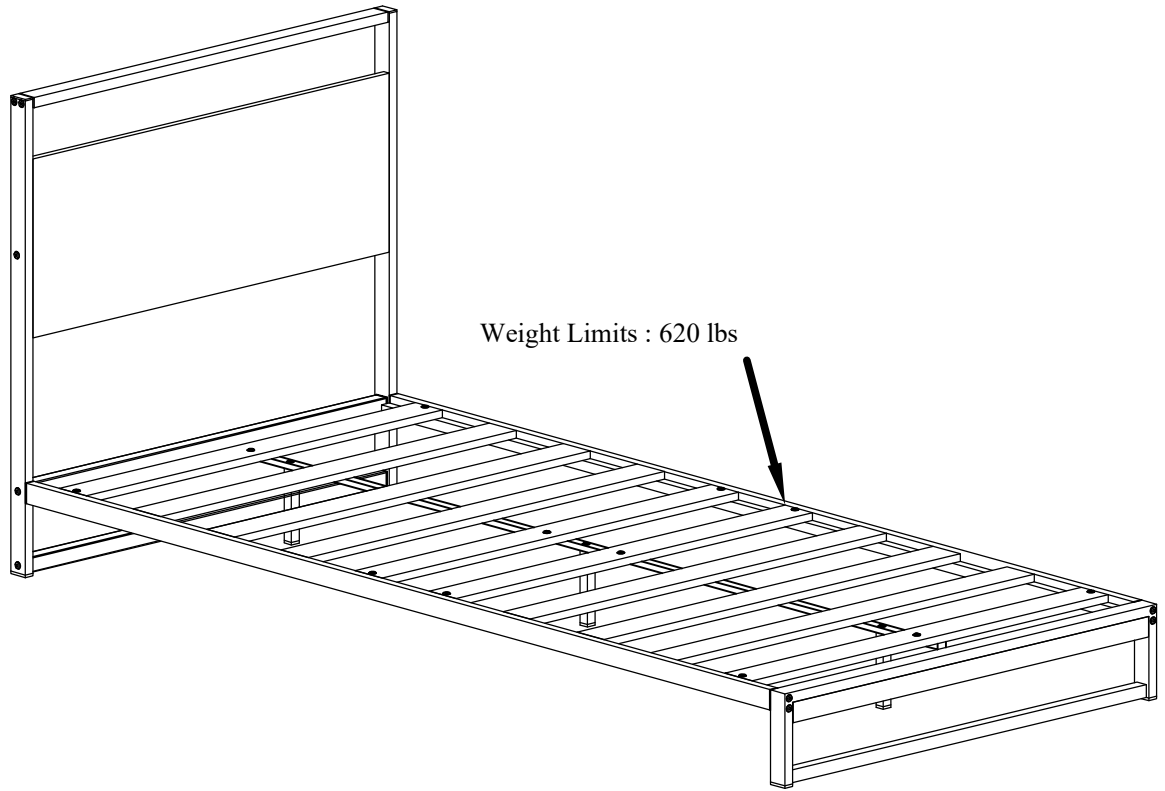

## PART LIST

1

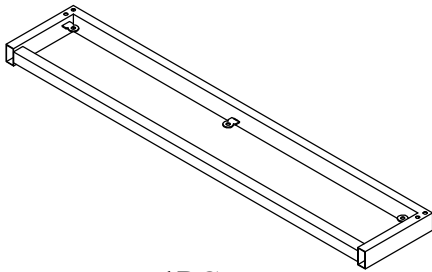

1PC

2

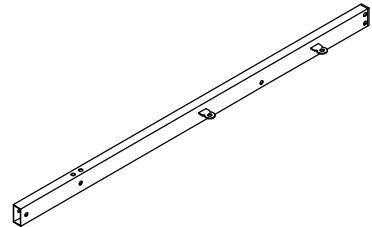

1PC

3

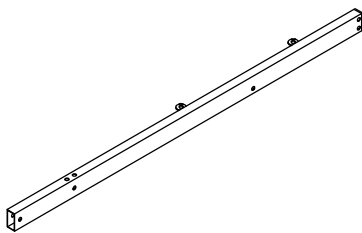

1PC

4

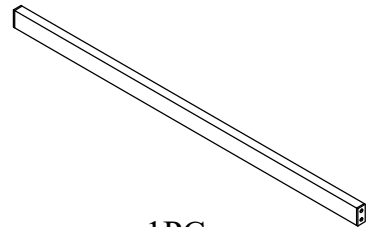

1PC

5

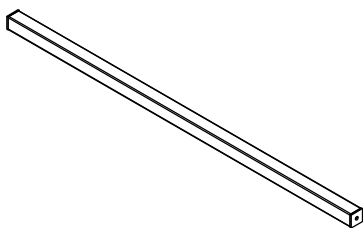

2PCS



6







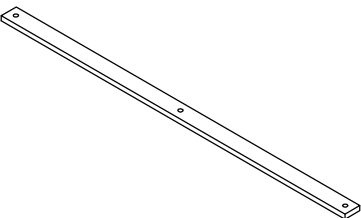
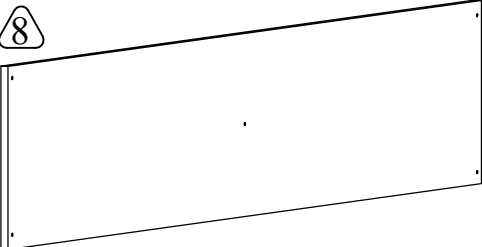
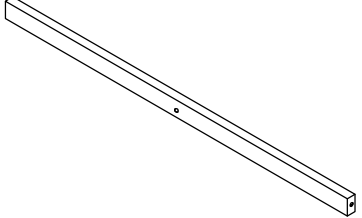
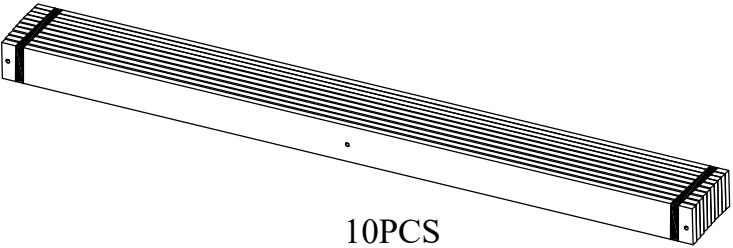
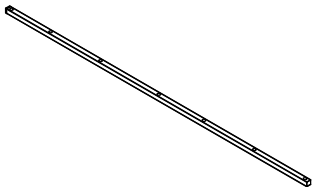





2PCS

# Low Profile Platform Bed ASSEMBLY INSTRUCTIONS





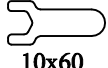





## PART LIST

 <b>7</b> <b>1PC</b>	 <b>8</b> <b>1PC</b>	 <b>12</b> <b>1PC</b>
 <b>9</b> <b>10PCS</b>	 <b>10</b> <b>1PC</b>	 <b>11</b> <b>3PCS</b>

## HARDWARE LIST

<b>A</b>	<b>B</b>	<b>C</b>	<b>D</b>	<b>E</b>	<b>F</b>	<b>G</b>	<b>H</b>	<b>K</b>	<b>L</b>
									
<b>1/4"×60</b> <b>8PCS</b>	<b>1/4"×50</b> <b>4 SETS</b>	<b>1/4"×40</b> <b>13PCS</b>	<b>1/4"×30</b> <b>8PCS</b>	<b>1/4"×12</b> <b>7PCS</b>	<b>20x40x10</b> <b>4PCS</b>	<b>20x20x10</b> <b>3PCS</b>	<b>4x60</b> <b>2PCS</b>	<b>10x60</b> <b>1PCS</b>	<b>1/4"×20</b> <b>1PCS</b>



### IMPORTANT SAFETY NOTICE: READ CAREFULLY BEFORE BEGINNING ASSEMBLY!

-  Keep desiccant, hardware packs and small components away from children, avoid eating and injuring.
-  Please do follow assembly steps.
-  Please do not lock any screws before each assembling unit is well placed in appropriate position.
-  Please do make sure all components are firmly locked after assembly and before use to avoid any potential safety hazard.
-  Please do use product correctly by it's origin purpose to avoid any danger happened.
-  Please do not stand on any part of components, except the ladder of this product after complete assembly.
-  If product is required to lock on the wall, please do so in case of any safety hazard happened before use.
-  Please check all contents of this product inside the carton (s) carefully, small parts may lost during shipment, if any of this happened, please contact the retailer from who you purchased this product to obtain replacement, do not use any substitute items.
-  This assembly instructions booklet contains important safety information, please read carefully before assembly and keep for further reference.
-  This products is designed referring to overall loading of each set final product, Please avoid to load on single point of final product making damaged  
product name : Pauletta Platform Bed (item 133Q) overall loading: 620 LBS (maximum)

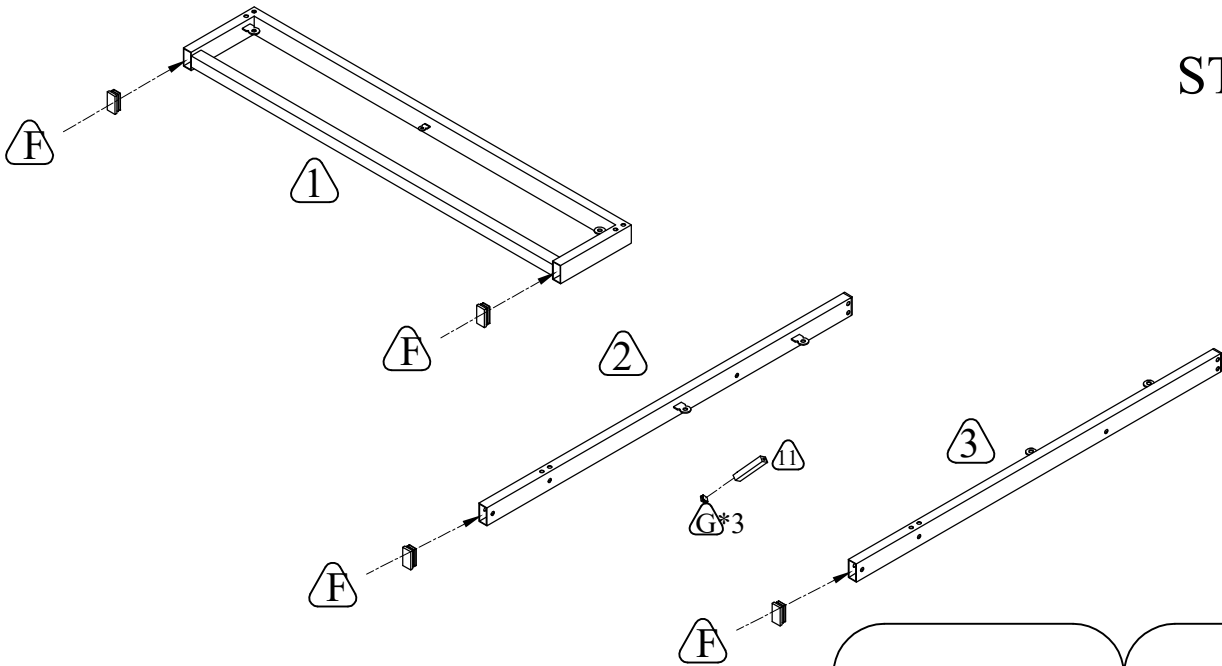
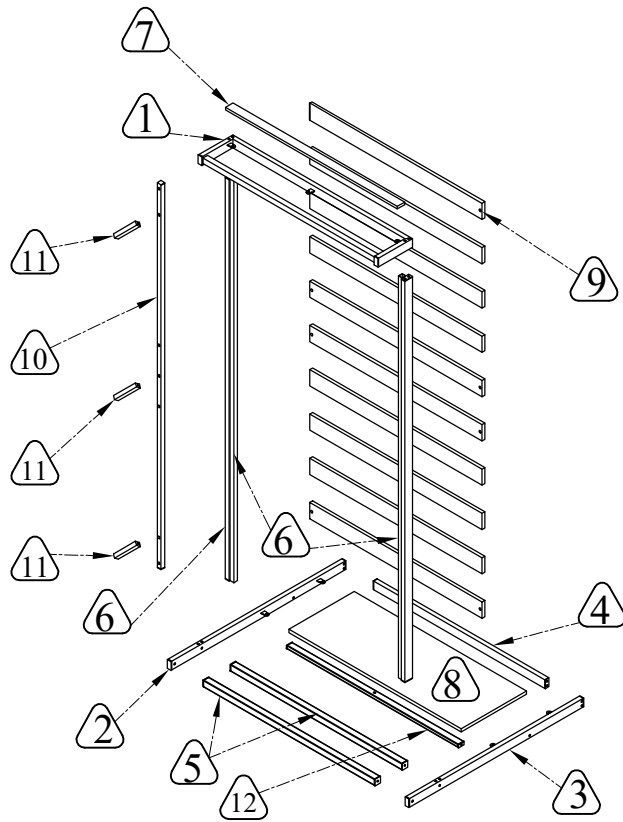
# Low Profile Platform Bed ASSEMBLY INSTRUCTIONS

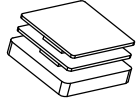

**STEP 1**

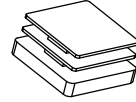
  <b>20x40x10</b> <b>4PCS</b>	  <b>20x20x10</b> <b>3PCS</b>
--	--

Low Profile Platform Bed  
ASSEMBLY INSTRUCTIONS

STEP 2

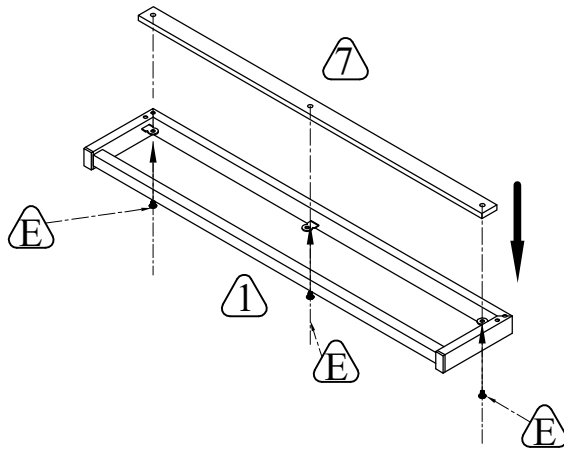

1/4" * 12 3 PCS	4x60 2PCS

STEP 3

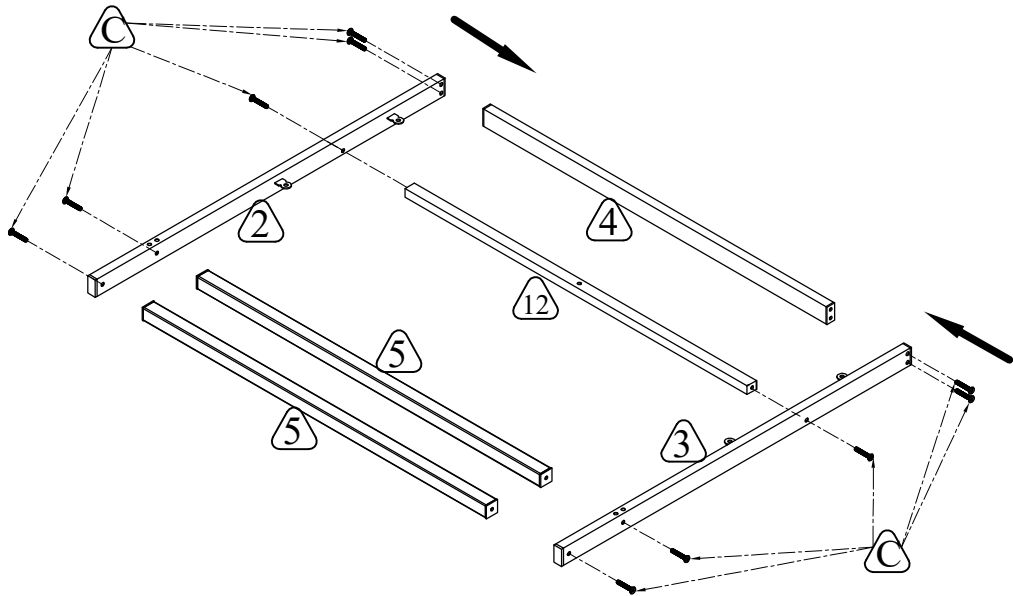

1/4" * 40 10 PCS	4x60 2PCS

Low Profile Platform Bed  
ASSEMBLY INSTRUCTIONS



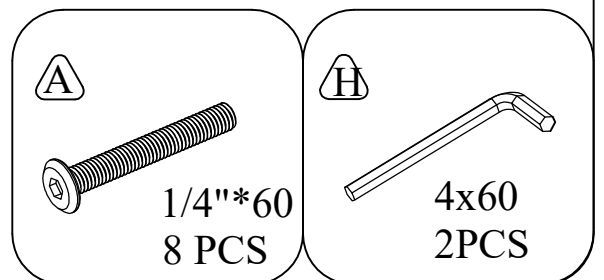
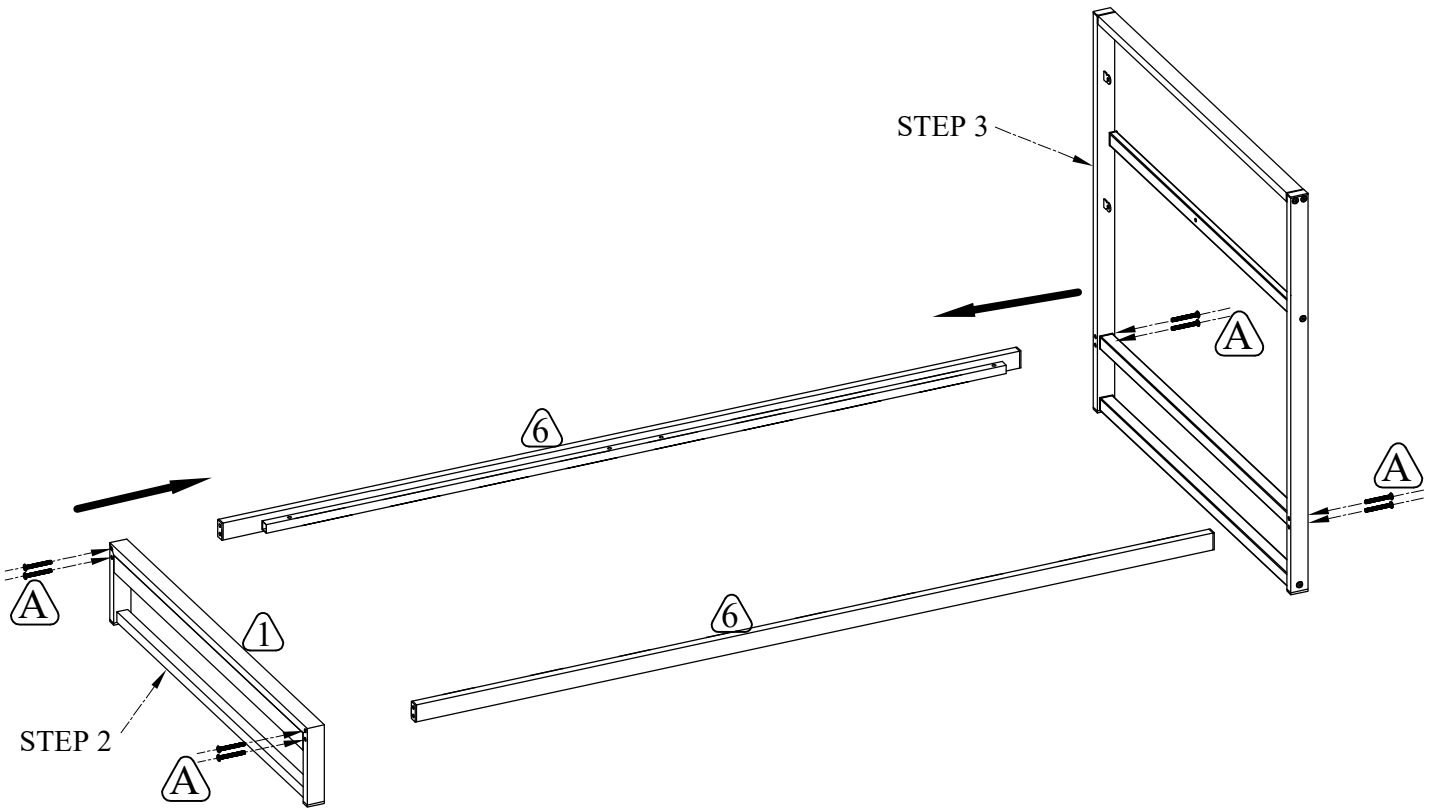



STEP 4

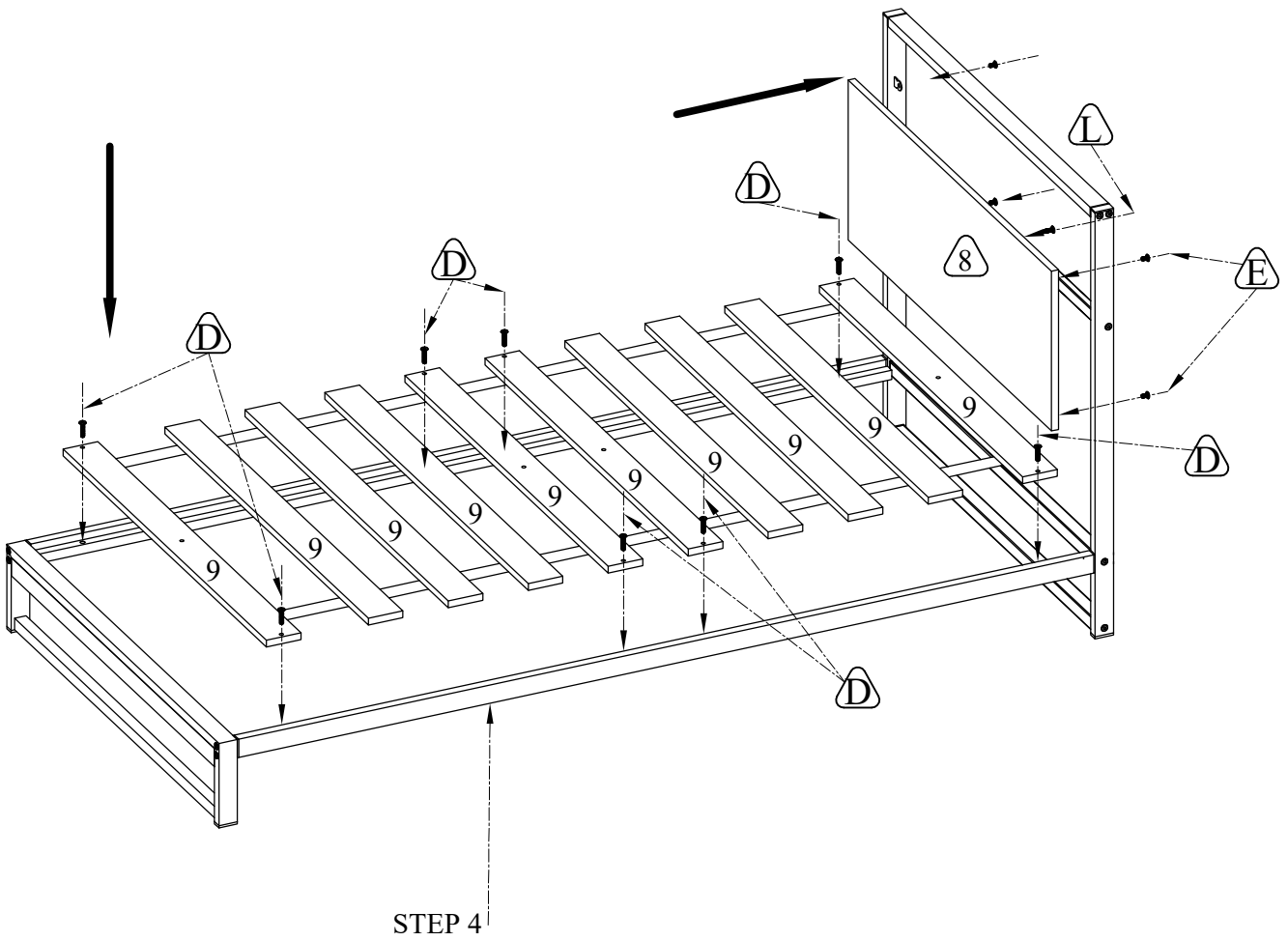

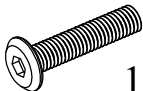
Low Profile Platform Bed  
ASSEMBLY INSTRUCTIONS

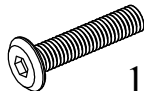
STEP 5



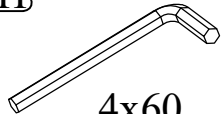



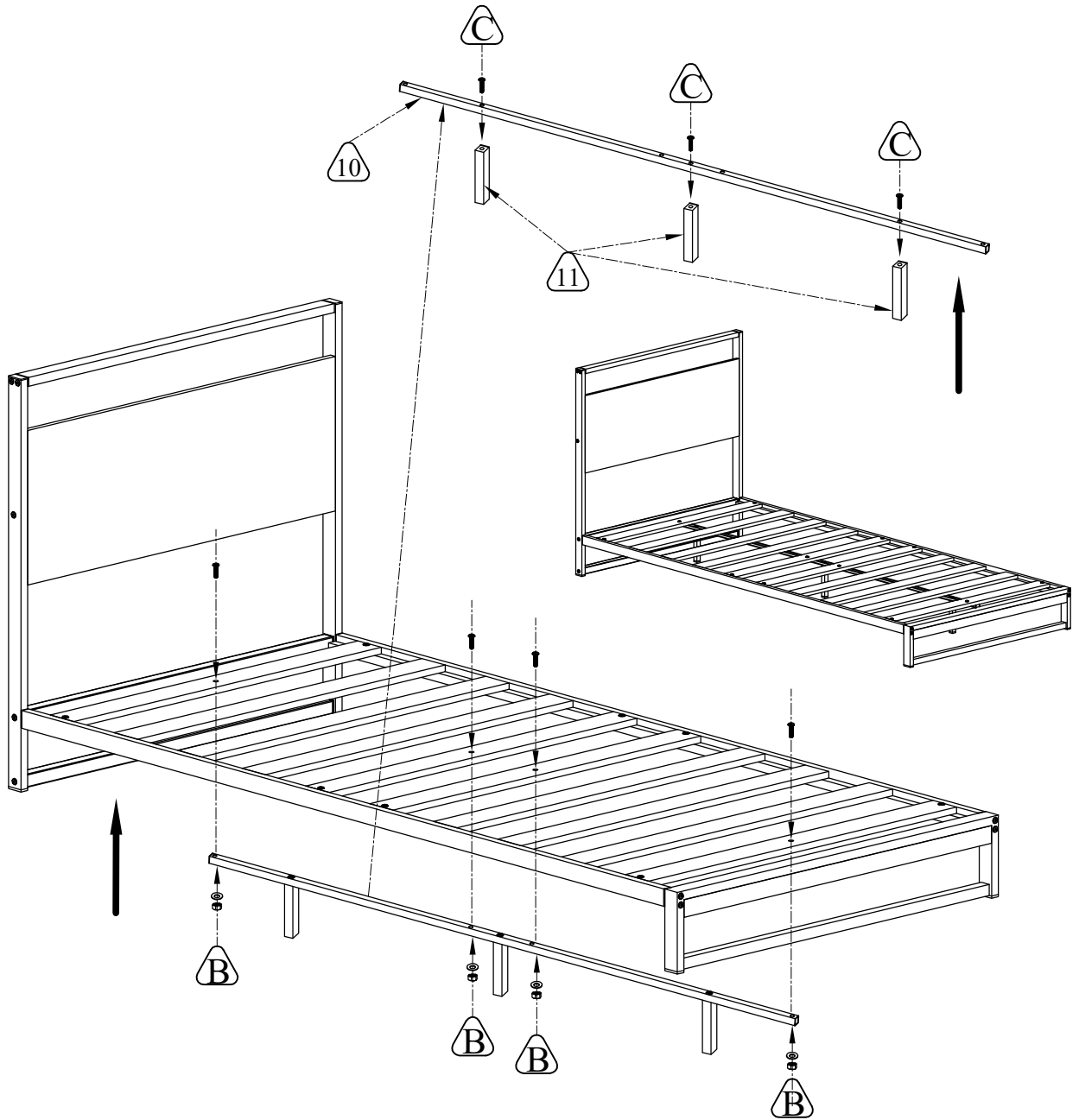

  1/4" * 20 1 PCS	  1/4" * 30 8 PCS	  1/4" * 12 4 PCS	  4x60 2 PCS
--	--	--	---

# Low Profile Platform Bed ASSEMBLY INSTRUCTIONS

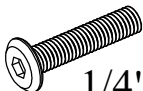
## STEP 6

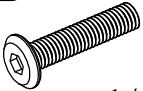
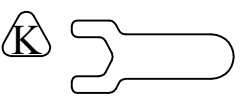

   1/4"*50 4 SETS	  1/4"*40 3 PCS	 10x60 1PCS	 4x60 2PCS
--	--	---	---